

NOTICE DE MONTAGE

CLAPIER FIRST DOUBLE (Réf S2675)

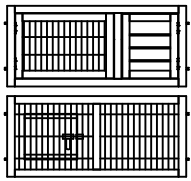

2 panneaux avant

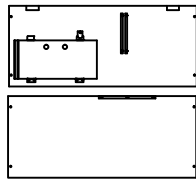

2 panneaux arrière

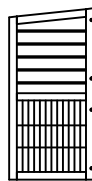

1 panneau gauche

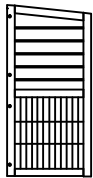

1 panneau droit



1 toit

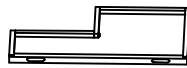







1 tiroir de déjection



1 cloison



1 rampe

- (A)  M3. 5X45
8+1
- (B)  M3. 5X30
8+1
- (C)  M3. 0X16
16+1
- (D)  M3. 0X14
8+1
-  béquille
-  2 loquets

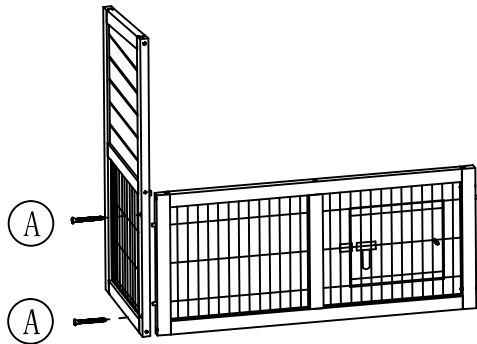

1. Fixer le panneau gauche avec les 2 panneaux avant.

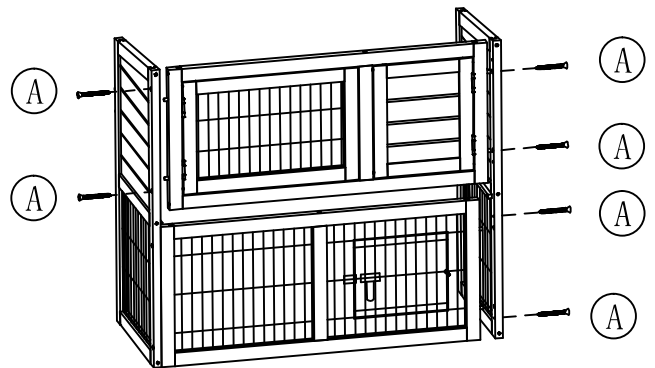

2. Fixer le panneau droit.

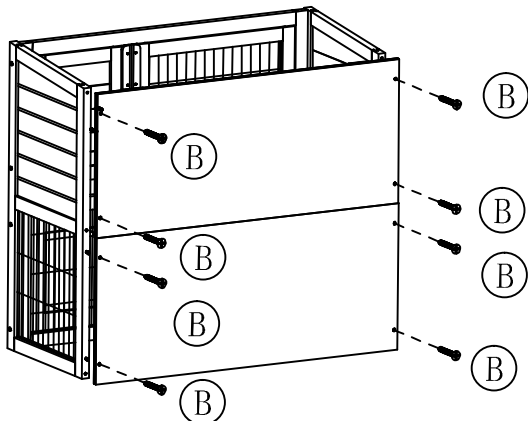

3. Fixer les 2 panneaux arrière.

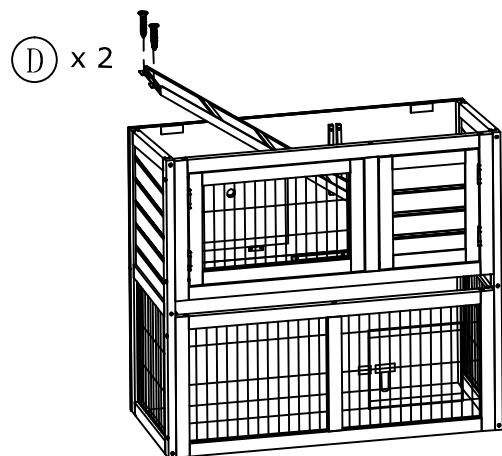

4. Insérer la rampe d'accès étage.