

NOTICE DE MONTAGE

POULAILLER MISSISSIPI (Réf 1346)

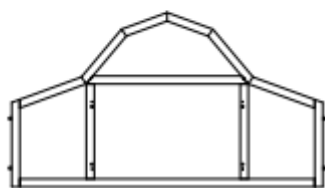

1 panneau avant supérieur



1 panneau arrière supérieur

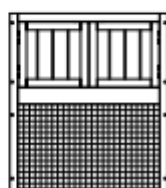

2 panneaux latéraux

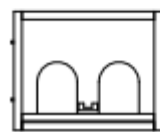

2 panneaux latéraux centraux

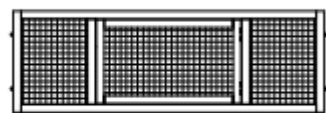

1 panneau grillagé avant

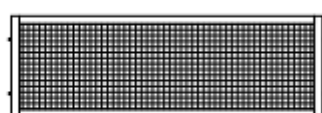

1 panneau grillage arrière



2 fonds de poulailler



2 barres de toit



1 tiroir de déjection



2 séparations de pondoir



1 perchoir amovible



1 rampe d'accès



2 panneaux inférieurs de toit



2 panneaux centraux de toit



2 panneaux supérieurs de toit



1 faitage de toit

(A)  M3.5X45
24+1

(B)  M3.5X35
16+1

(C)  M3.5X25
4+1

(D)  M3.0X16
44+1



7 serrures

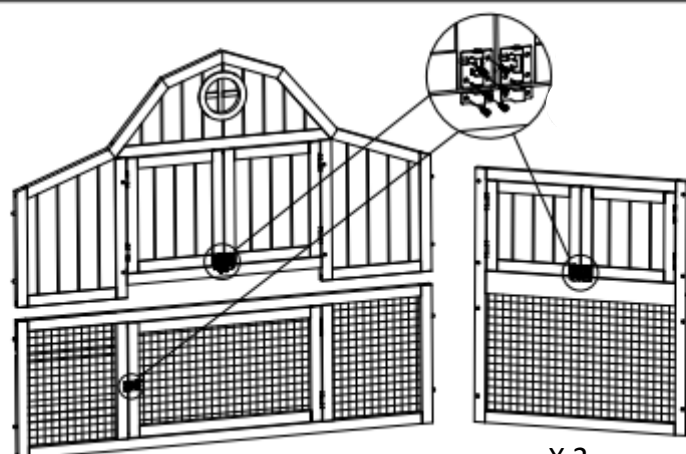

1. Fixer les serrures.

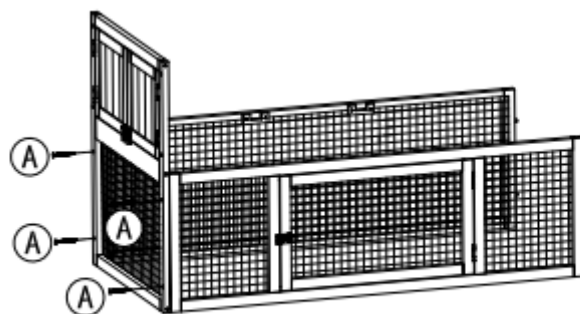

2. Fixer tous les panneaux grillagés entre eux.

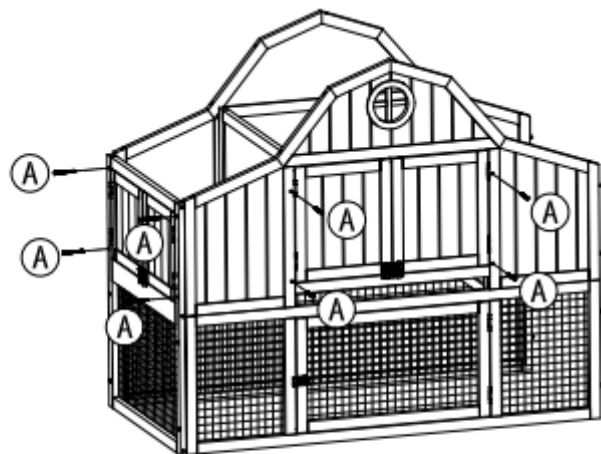

3. Assembler tous les panneaux supérieurs bois et les panneaux latéraux centraux.

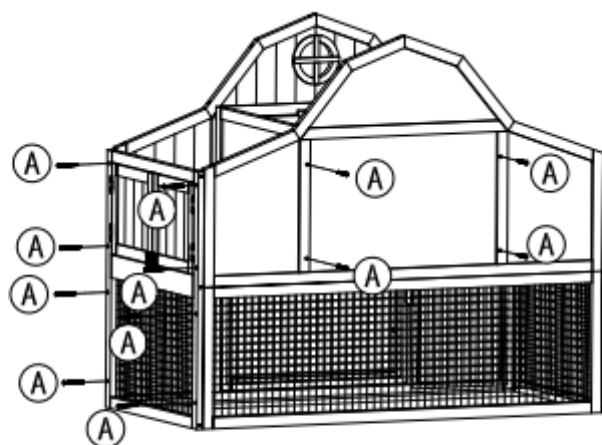

4. Fixer les panneaux latéraux.

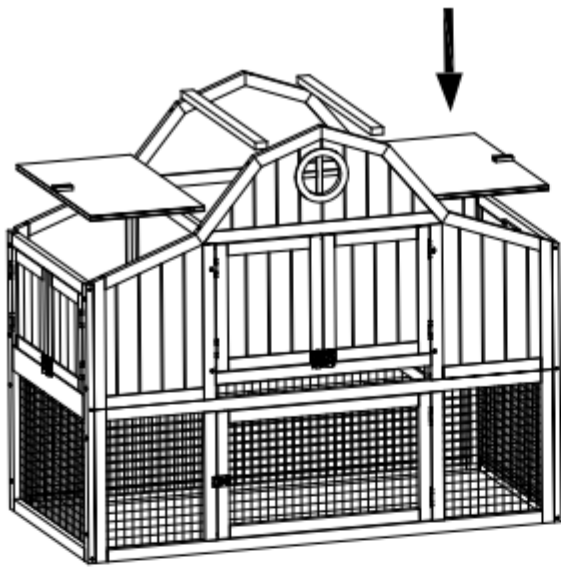

5. Fixer les 2 fonds de poulailler ainsi que les barres de toit.

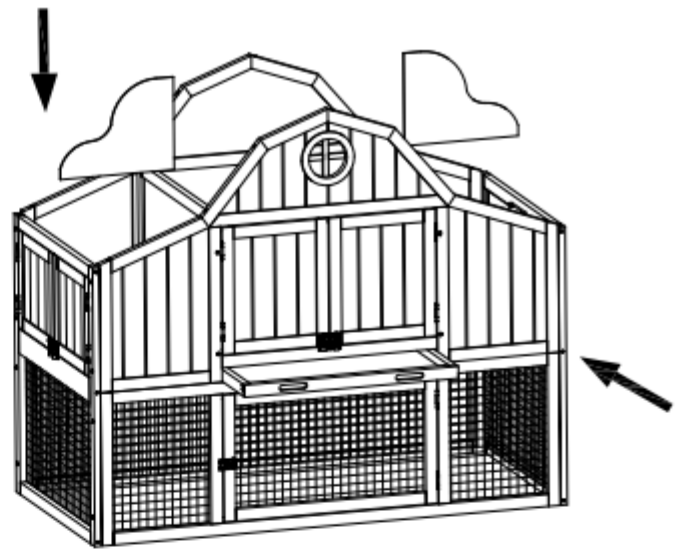

6. Insérer les séparations de pondoir et le tiroir de déjection.

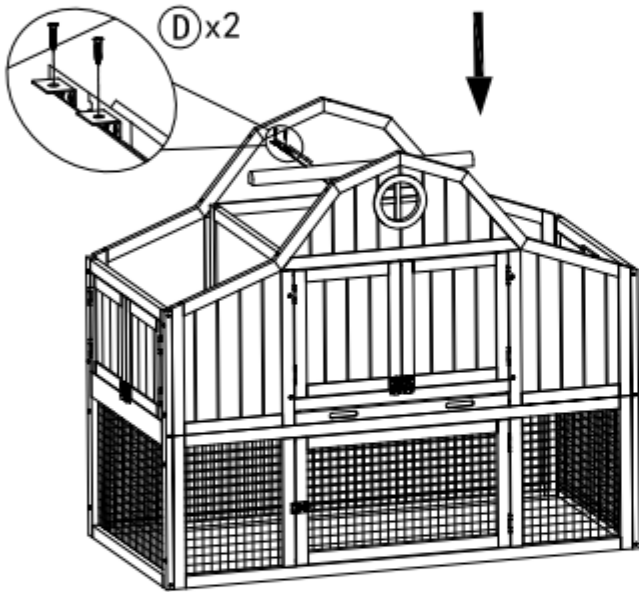

7. Fixer la rampe d'accès et le perchoir amovible.

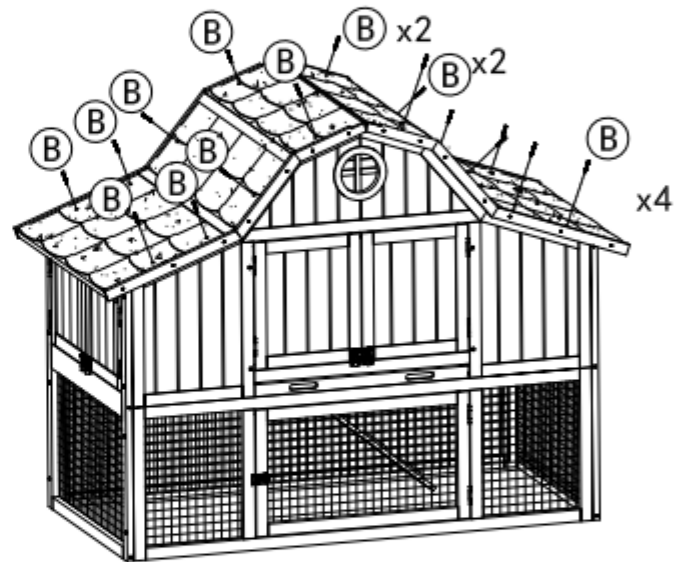

8. Fixer tous les panneaux de toit.

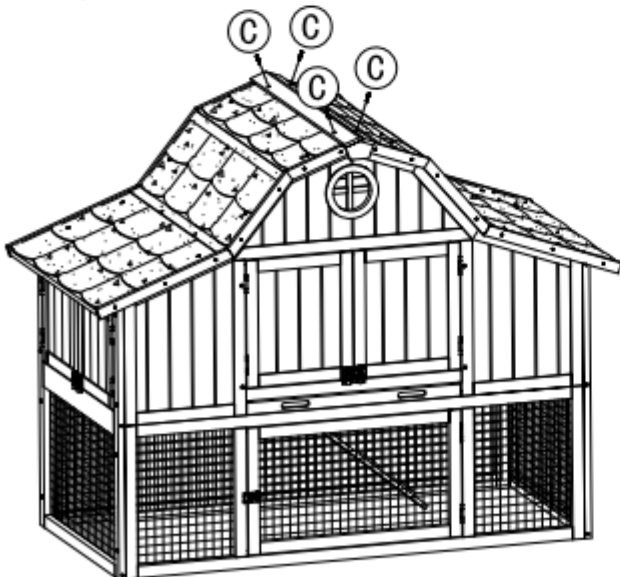

9. Fixer le faitage.

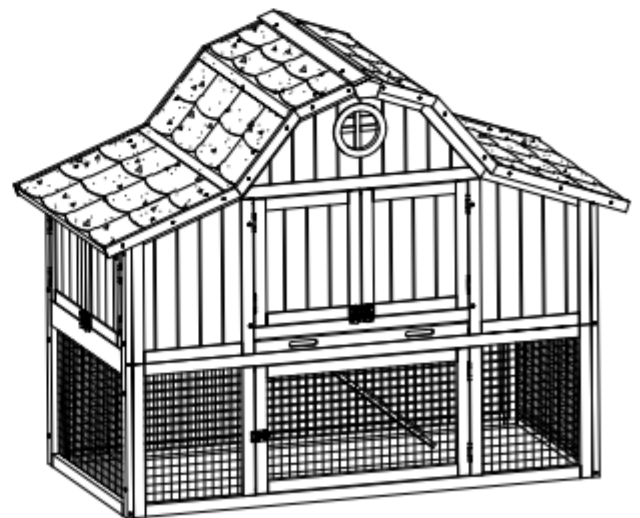

10. C'est fini!