

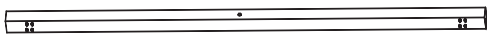

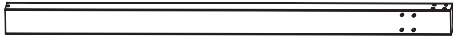

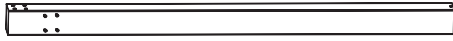



Pergola adossée toit rétractable - 3 x 3 m - gris anthracite  
1558\_136292



|   |   |              |    |     |
|---|---|--------------|----|-----|
| A |    | 30x40x2830mm | X1 | 1/1 |
| B |    | 60x60x2185mm | X1 | 1/1 |
| C |    | 60x60x2185mm | X1 | 1/1 |
| D |    | 30x40x2830mm | X1 | 1/1 |
| E |    | 30x40x2830mm | X1 | 1/1 |
| F |    | 30x40x2830mm | X1 | 1/1 |
| G |   | DIA16x1325mm | X4 | 1/1 |
| H |  | DIA13x1380mm | X4 | 1/1 |
| I |  | DIA16x1325mm | X1 | 1/1 |
| J |  | DIA13x1380mm | X1 | 1/1 |
| K |  |              | X1 | 1/1 |
| L |  |              | X3 | 1/1 |

FR : SAV/INFORMATION /VIDEO/CONTACT

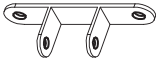
EN: AFTER-SALES SERVICE/INFORMATION/VIDEO/CONTACT

DE : REPARATUR-SERVICE UND ERSATZTEILE /INFORMATIONEN /VIDEO/KONTAKT

ES: SERVICIO POST-VENTA/INFORMACI N/VIDEO/CONTACTO

IT: SERVIZIO ASSISTENZA/INFORMAZIONI/VIDEO/CONTATTO

PT: SERVIÇO POS-VENDA/INFORMAÇÕES/VIDEO/CONTATO













PL: SERWIS TECHNICZNY/INFORMACJE/WIDEO/KONTAKT

NE: AFTER SALES SERVICE/INFORMATIE/VIDEO/CONTACT

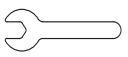
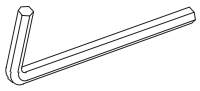
HE: מע רשקתל/ואדיווה/ עדימ/תוריכמו תורישי רחאל

[SAV.HABITATETJARDIN.COM](http://SAV.HABITATETJARDIN.COM)

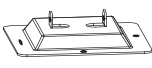
2024-2025

|   |   |              |     |     |
|---|---|--------------|-----|-----|
| M |    | M6x55mm      | X1  | 1/1 |
| N |    | M6x15mm      | X4  | 1/1 |
| O |    | M6x45mm      | X3  | 1/1 |
| P |    | M6x45mm      | X3  | 1/1 |
| Q |    |              | X6  | 1/1 |
| R |    | M5x15mm      | X8  | 1/1 |
| S |    | M6x44mm      | X16 | 1/1 |
| T |   |              | X1  | 1/1 |
| U |  |              | X1  | 1/1 |
| V |  | DIA3.5x147mm | X8  | 1/1 |
| W |  |              | X1  | 1/1 |
| X |  | 30x40x85mm   | X5  | 1/1 |
| Y |  | 147x147mm    | X2  | 1/1 |
| Z |  |              | X1  | 1/1 |

FR : SAV/INFORMATION /VIDEO/CONTACT

EN: AFTER-SALES SERVICE/INFORMATION/VIDEO/CONTACT

DE : REPARATUR-SERVICE UND ERSATZTEILE /INFORMATIONEN /VIDEO/KONTAKT

ES: SERVICIO POST-VENTA/INFORMACION/VIDEO/CONTACTO

IT: SERVIZIO ASSISTENZA/INFORMAZIONI/VIDEO/CONTATTO

PT: SERVIÇO POS-VENDA/INFORMAÇÕES/VIDEO/CONTATO

PL: SERWIS TECHNICZNY/INFORMACJE/WIDEO/KONTAKT

NE: AFTER SALES SERVICE/INFORMATIE/VIDEO/CONTACT

HE: מע רשקתל/ואדיווה/ עדימ/תוריכמו תורישי רחאל

[SAV.HABITATETJARDIN.COM](http://SAV.HABITATETJARDIN.COM)

2024-2025

STEP 1

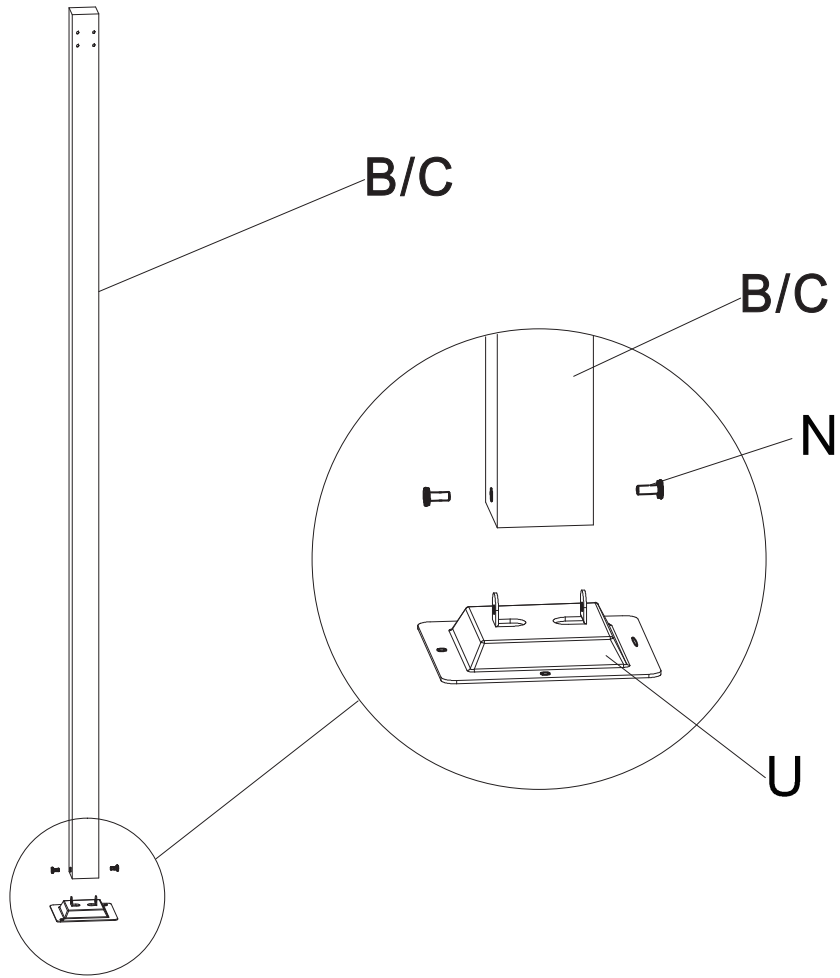

STEP 2

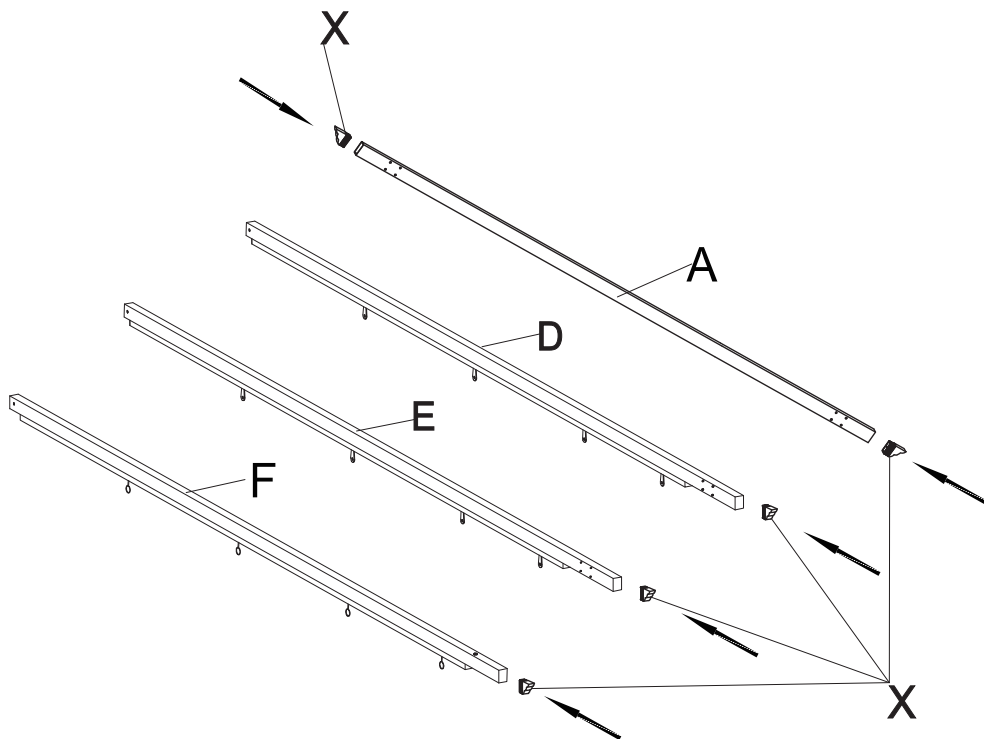

STEP 3

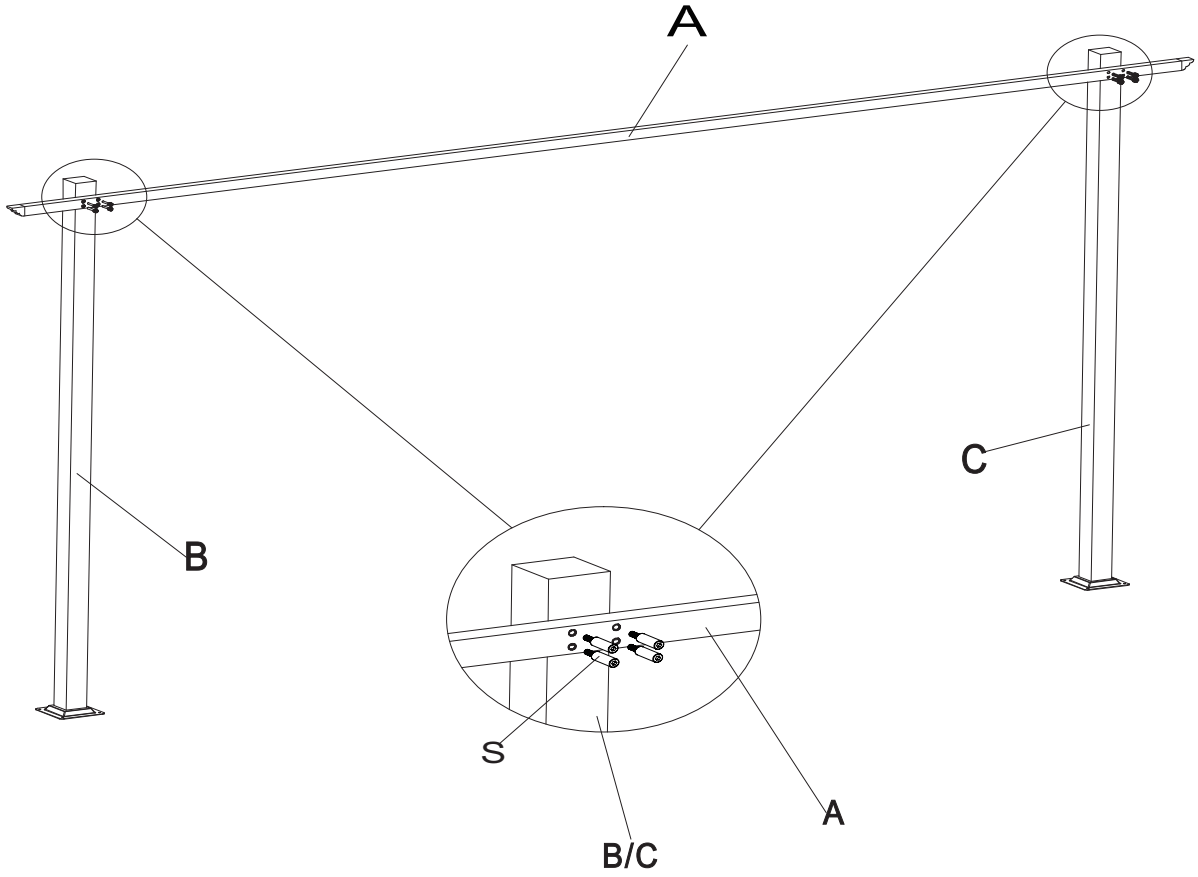

STEP 4

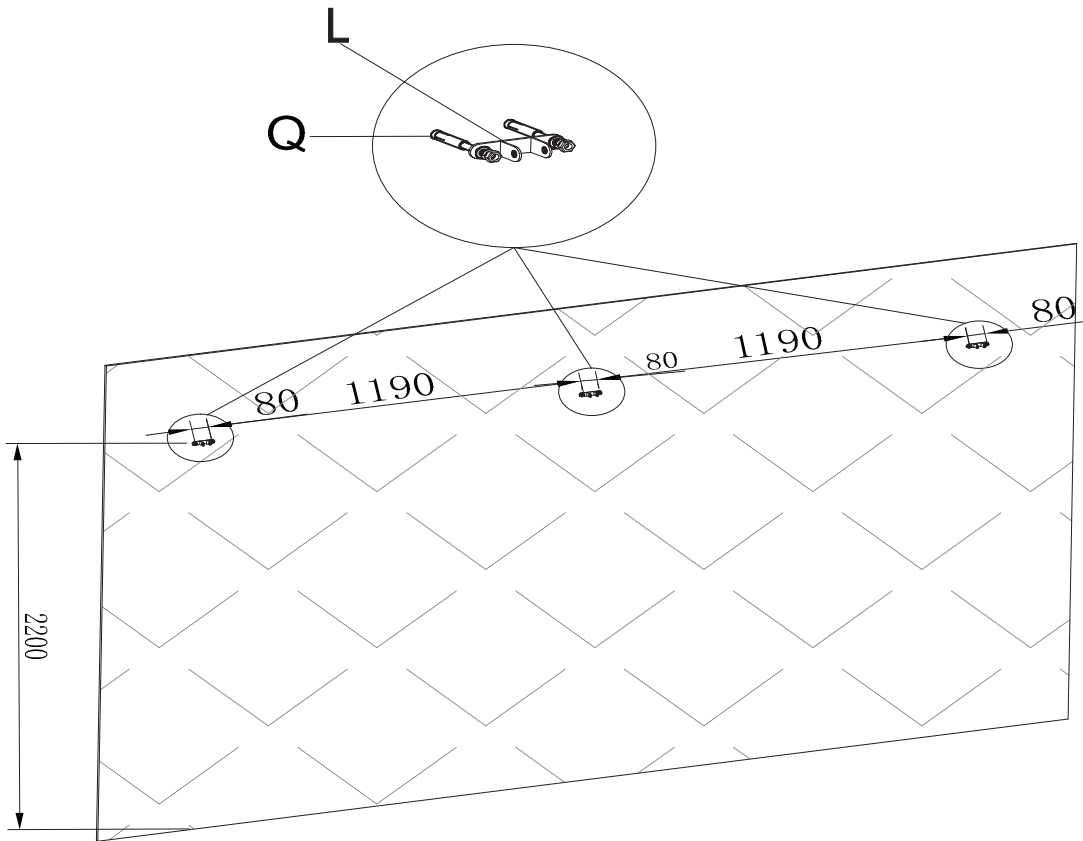

STEP 5

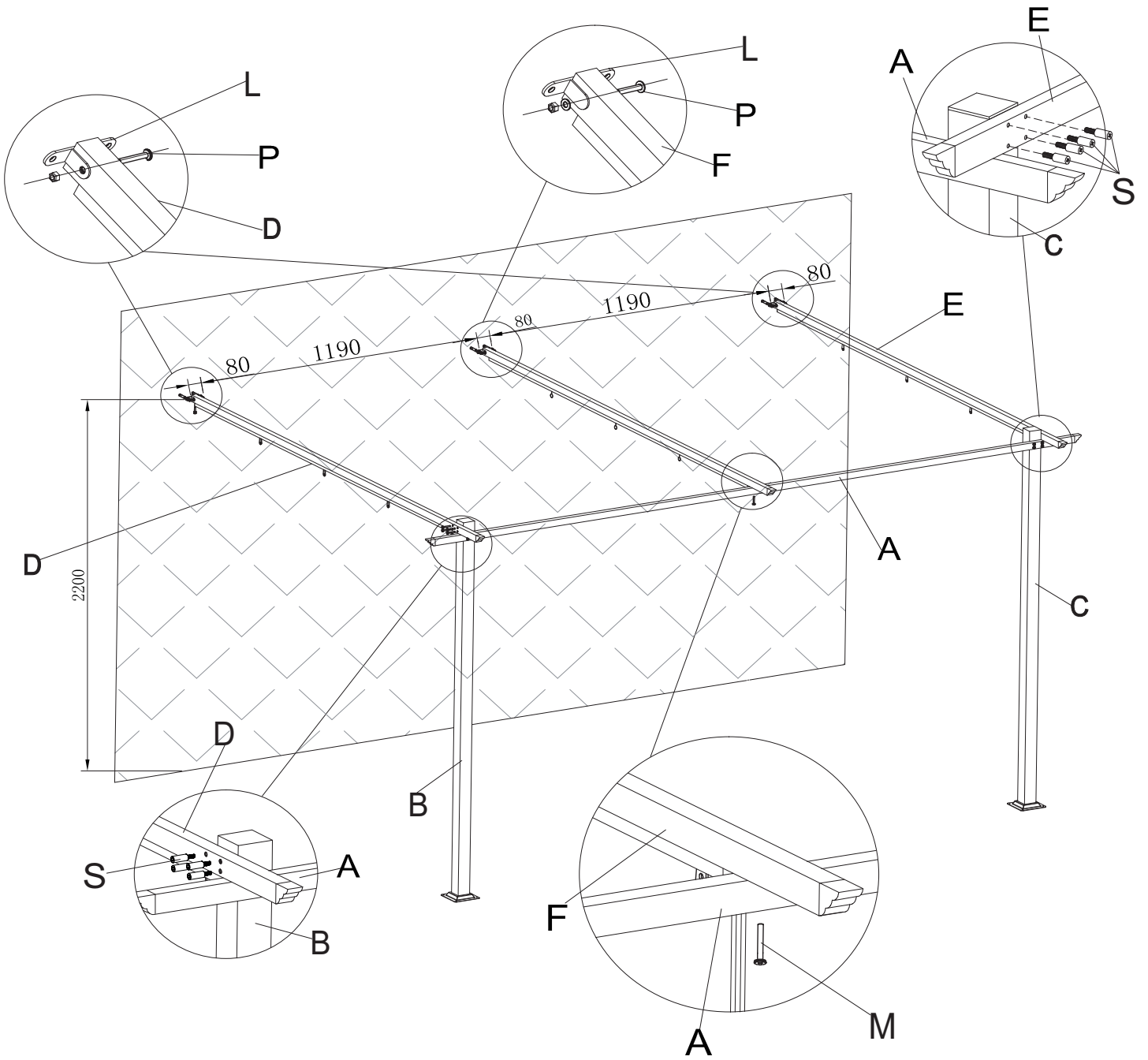

STEP 6

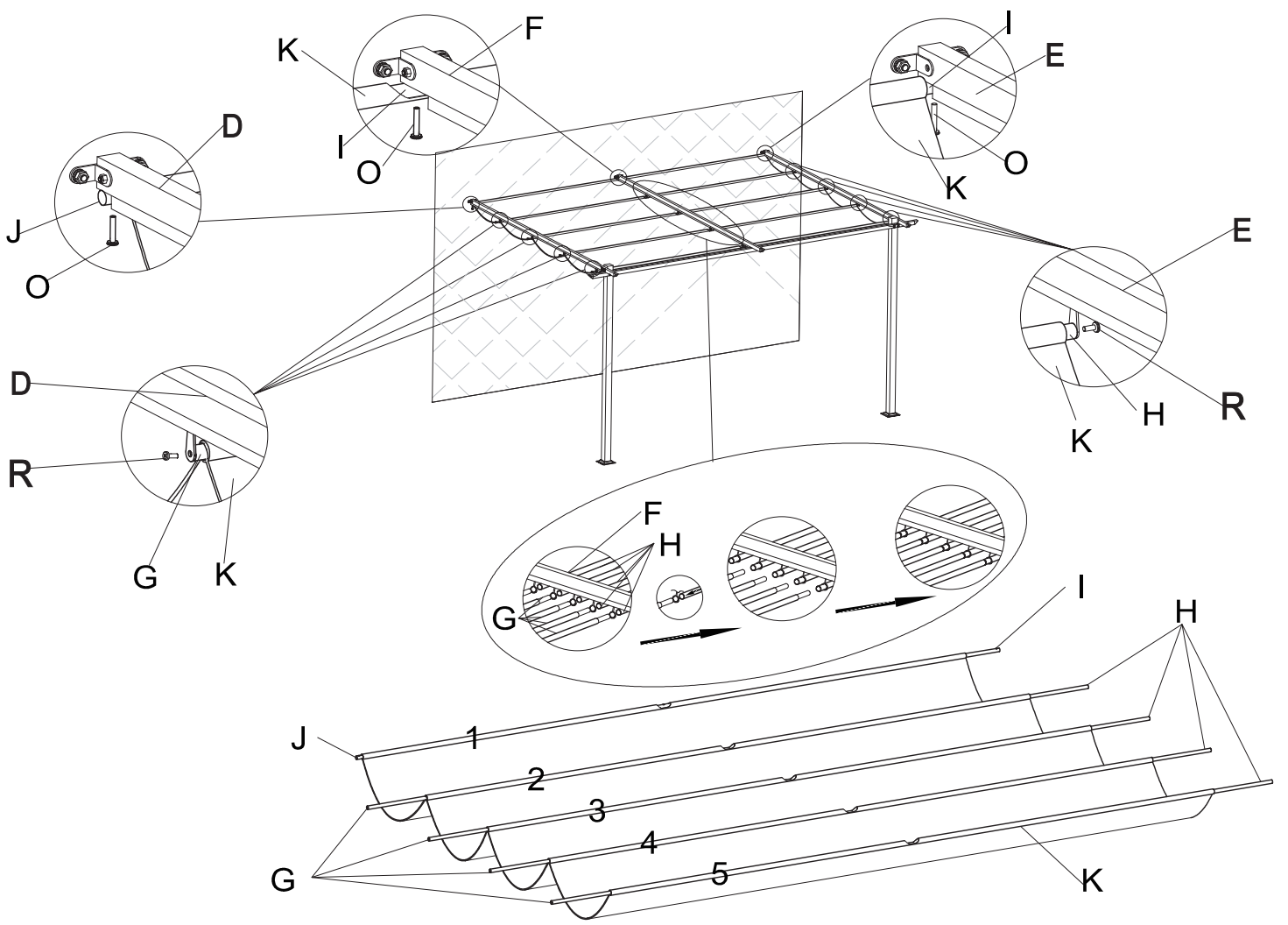

STEP 7

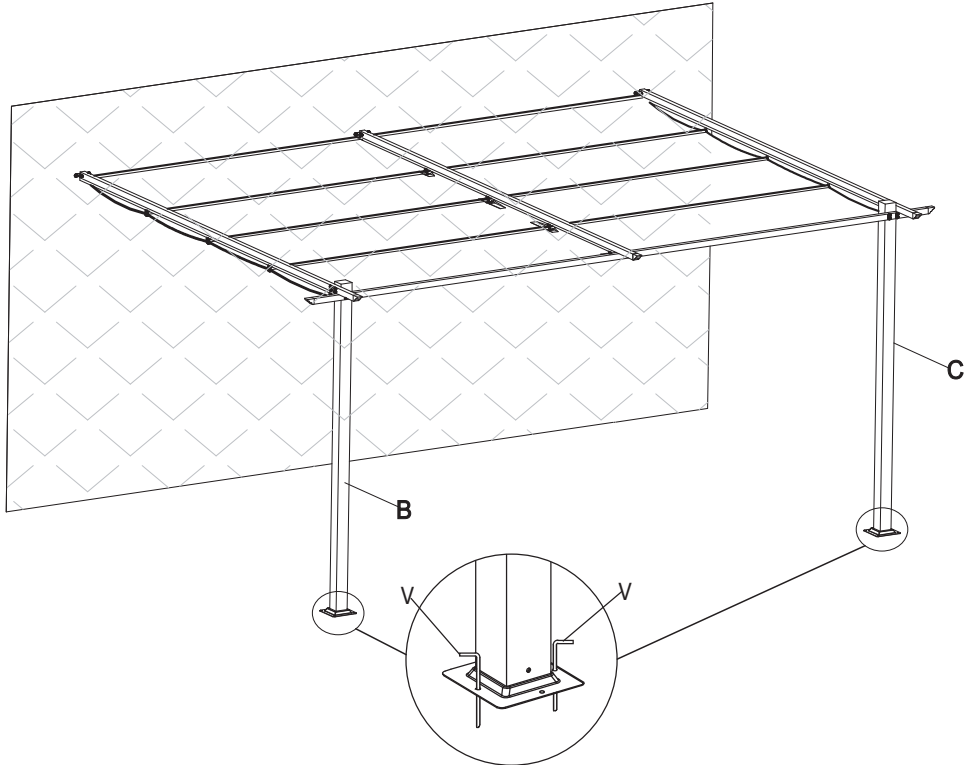

STEP 8

