

TRIGANO

JARDIN

Abri en résine J-ABR287 Instruction de montage



2 PERSONNES REQUISES

POUR UN MONTAGE DE 2 HEURES





ABRI J-ABR 287 - Dimensions 131x131x196 cm

Manuel du propriétaire

Veillez consulter les normes de construction locales relatives à l'emplacement de votre abri et aux autres exigences avant de commencer le montage.

Instructions de montage

Lisez toutes les instructions et informations appropriées avant de commencer le montage. Assurez-vous de suivre attentivement l'ordre des étapes afin d'obtenir de bons résultats.

Accueil de l'abri

Vous devez décider d'un emplacement pour votre abri avant le montage, choisissez un emplacement plat et de niveau, pour permettre à l'eau de s'évacuer.

Préférez un endroit avec une exposition limitée aux vents dominants, notamment sur les faces comportant des ouvertures. L'accueil doit être d'environ 10 cm plus large que le support de l'abri (une dalle de béton d'une épaisseur minimale de 10 cm est recommandée).

Assurez-vous de disposer d'un espace de travail suffisant pour positionner aisément les pièces lors du montage. Veillez à ce que l'entrée soit suffisamment dégagée pour permettre une ouverture complète des portes, et prévoyez assez d'espace autour de l'abri pour fixer les vis de l'extérieur.

La condensation dans un abri de jardin est principalement causée par l'humidité présente dans les fondations. Cette humidité se diffuse dans l'air chaud à l'intérieur de l'abri, puis se condense sur les surfaces froides des murs et du toit formant des gouttelettes.

Pour lutter contre la condensation, il est essentiel de prévenir l'humidité dans les fondations de l'abri. Voici quelques étapes à suivre avant l'installation d'un abri métallique :

Préparation de la fondation :

La dalle de béton ou la fondation doit être à peine plus grande que la surface de l'abri et parfaitement horizontale. Construisez la base de manière à permettre l'écoulement de l'eau. Les bords de la base en ciment doivent être inclinés pour faciliter l'écoulement de l'eau.

Exemple : Surface de l'abri = 2,36 m x 1,77 m et fondation = 2,43 m x 1,85 m.

Imperméabilisation :

Insérez une membrane imperméable à l'humidité avant de couler la dalle. Utilisez une toile de polythène épaisse et résistante sous la base pour empêcher l'humidité de monter du sol dans l'abri.

Après le coulage du béton, laissez sécher la fondation pendant au moins 7 jours.

Isolation et ventilation :

Recouvrez le toit de l'abri de jardin avec du feutre pour améliorer l'isolation.

Ouvrez périodiquement une porte ou une fenêtre de l'abri pour permettre à l'air frais et sec de circuler.

Application de mastic :

Appliquez un mastic pour extérieur sur les pièces d'armature de la base de l'abri. Ce mastic ne doit pas sécher complètement et doit rester souple.

Panneaux de polystyrène :

Si la condensation persiste, collez des panneaux de polystyrène de 25 mm d'épaisseur sous les panneaux de toiture entre les poutres du toit. Utilisez une colle résistante à l'humidité et à la température. Ces panneaux aident à maintenir une température plus fraîche à l'intérieur de l'abri pendant les journées chaudes.

En suivant ces étapes, vous pouvez réduire l'excès d'humidité dans les fondations et minimiser la condensation dans votre abri de jardin.

Ancrage : Votre abri de stockage doit être ancré afin d'éviter les dommages dus au vent.

Pièces de l'abri

Avant de commencer le montage, assurez-vous de disposer de la totalité des pièces nécessaires pour le montage de votre abri (reportez-vous à la page « *Liste des pièces* » en page 5). N'essayez pas de monter l'abri s'il vous manque des pièces.

Tout abri partiellement monté peut être gravement endommagé par des vents légers.

Veillez retirer la couche de protection de sécurité avant de commencer le montage.

Si nécessaire, conservez l'étiquette où figure le numéro de la pièce.

Outils nécessaires (liste non exhaustive)



La sécurité doit être la priorité

1. Choisissez une journée calme et sèche pour le montage. Le montage doit être effectué à plusieurs personnes (deux monteurs au minimum). Il est également recommandé de terminer le montage en une journée afin d'éviter d'endommager le produit ou de perdre des petites pièces. Conservez toutes les petites pièces (vis, etc.) dans un contenant pour ne pas les perdre.

2. Portez des gants de sécurité, des lunettes de protection et des manches longues pendant le montage afin d'éviter les blessures. Faites attention au bord tranchant de certaines pièces.

3. Gardez les enfants et les animaux domestiques hors du lieu de montage.

4. Ne reposez jamais tout votre poids sur le toit de l'abri. Assurez-vous d'être en sécurité avant d'utiliser un escabeau.

Entretien et maintenance

1. Nettoyez l'abri avec un chiffon doux, en utilisant de l'eau si nécessaire.

2. Veillez à enlever les saletés et autres débris qui pourraient empêcher les portes de se fermer facilement.

3. L'abri n'est pas fait pour y vivre. Il est destiné au stockage.

4. Veillez à ne pas laisser les portes ouvertes.

5. Ne laissez pas la neige s'accumuler sur le toit.

Utilisation





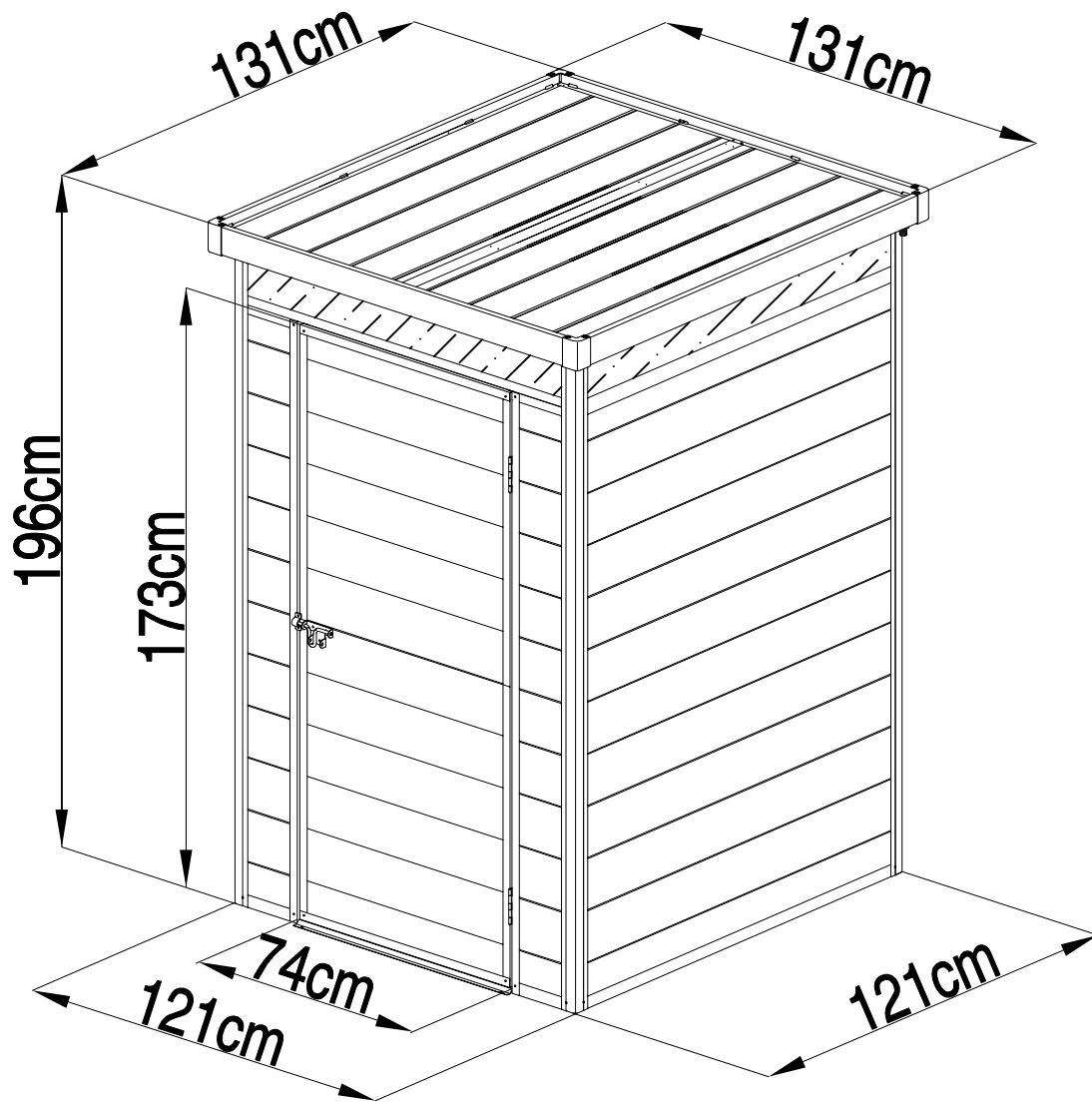

Il est déconseillé de stocker des produits chimiques à l'intérieur de l'abri.

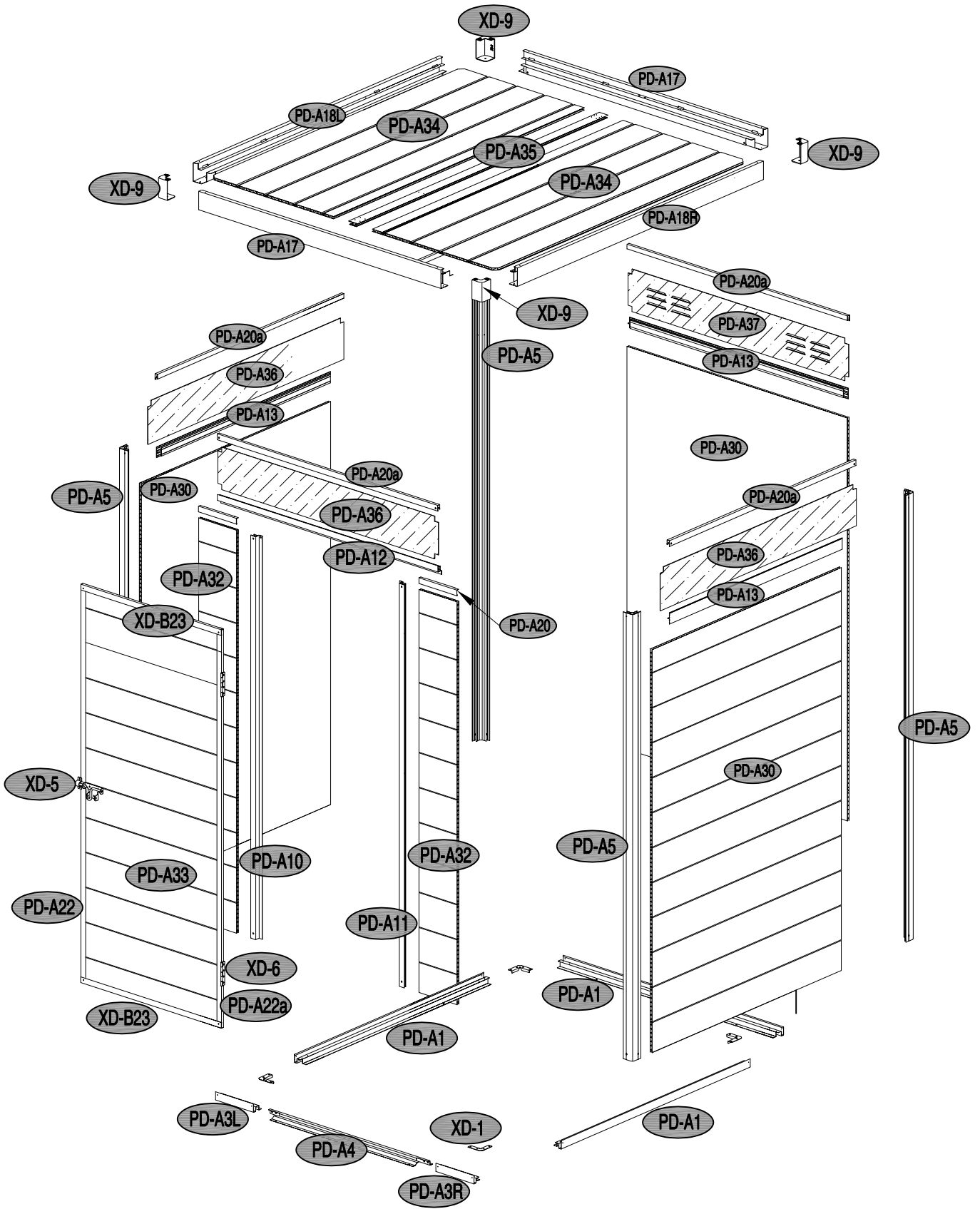
Garantie

2 ans pour défauts de matériaux ou de fabrication dans les conditions normales d'utilisation .





| | | | | | | | |
|----------|---|--|--|---|---|---|--|
| 1 |  PD-A1 x3 |  PD-A3L x1 |  PD-A3R x1 |  PD-A4 x1 |  XD-1 x4 |  PD-A50 x20 | |
|----------|---|--|--|---|---|---|--|

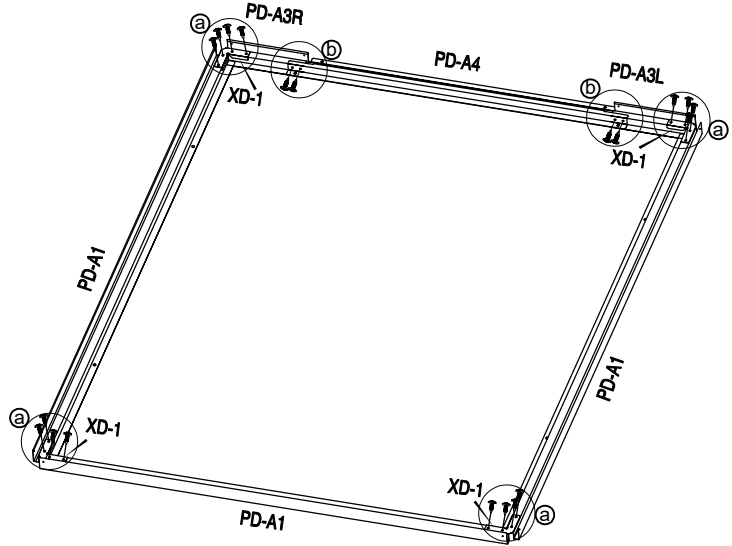
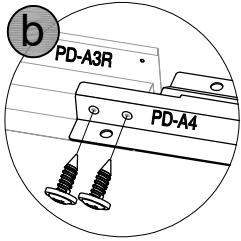
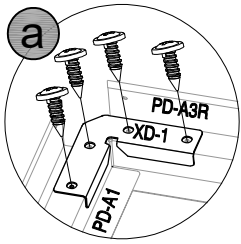

| | | | | | | | |
|----------|---|--|--|--|--|--|--|
| 2 |  PD-A5 x1 | | | | | | |
|----------|---|--|--|--|--|--|--|

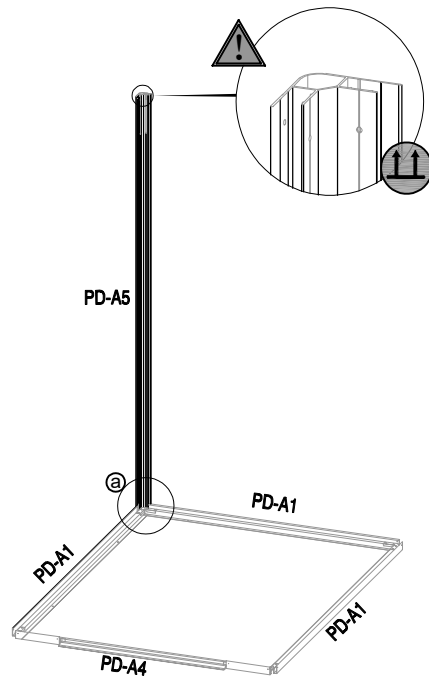
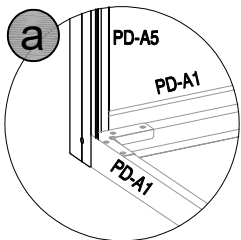
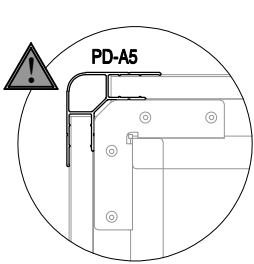

| | | | | | | | |
|-----------|---|--|--|--|--|--|---|
| 3 |  | | | | | |  CN-A33 |
| PD-A30 x2 | | | | | | | |

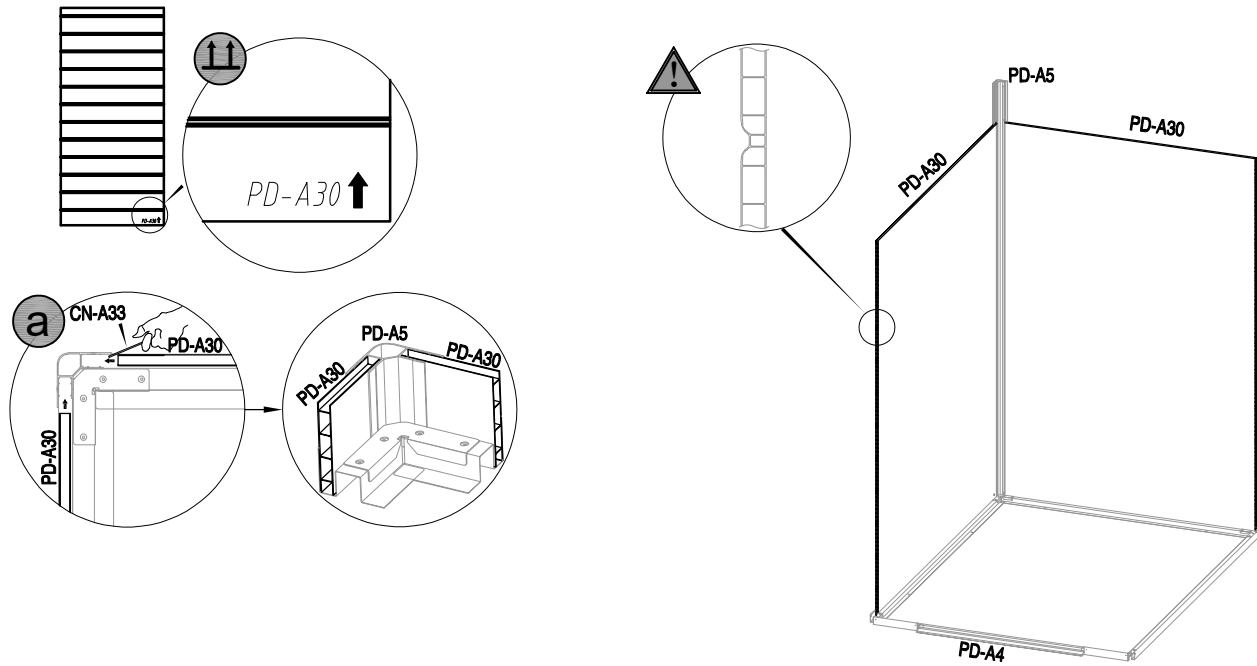

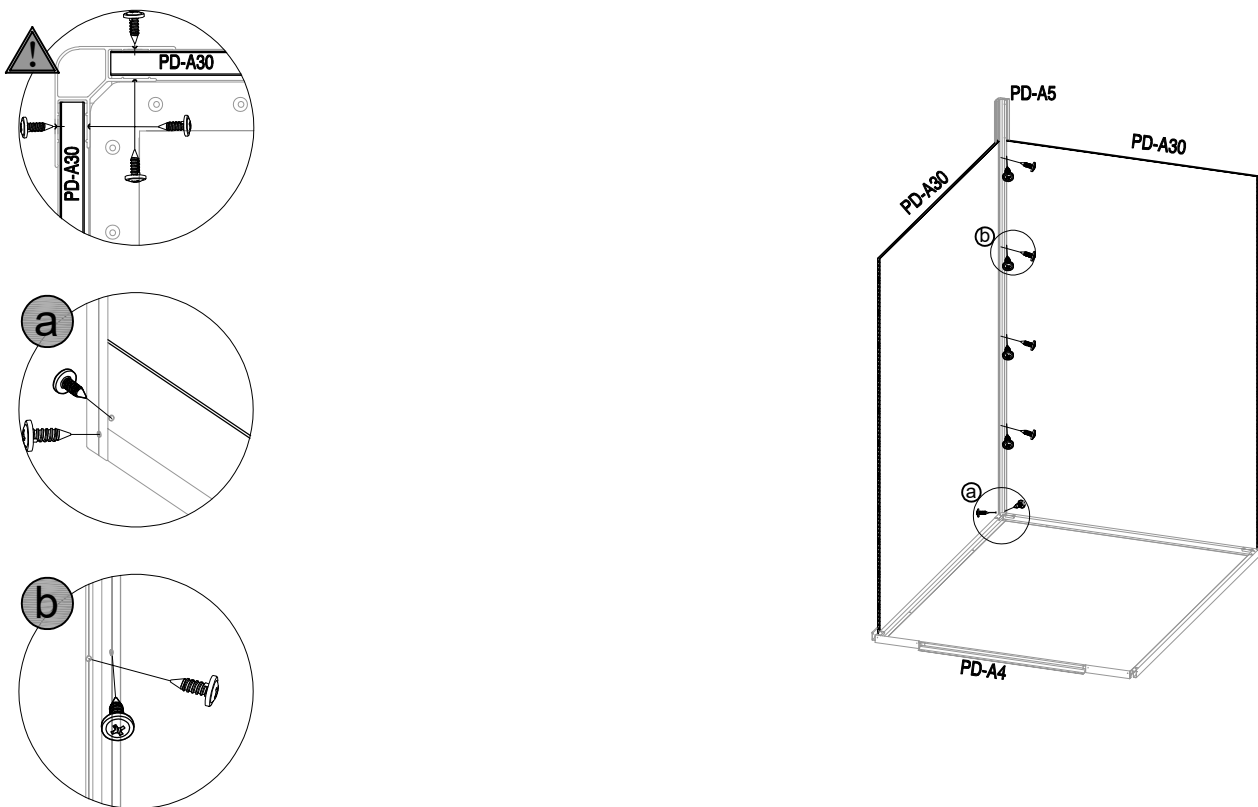

| | | | | | | | |
|------------|---|--|--|--|--|--|--|
| 4 |  | | | | | | |
| PD-A50 x10 | | | | | | | |

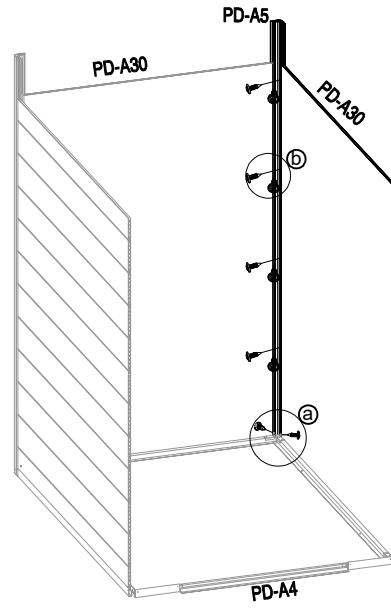
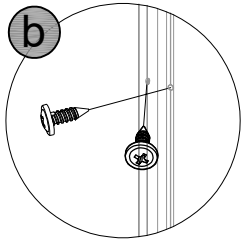
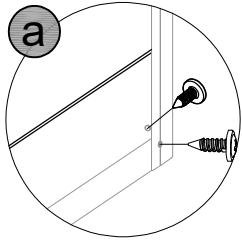
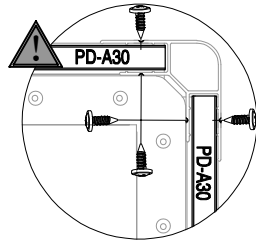
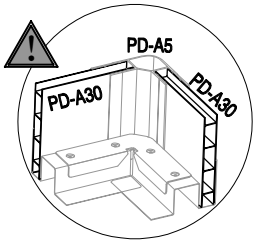

| | | | | | | | |
|---|---|--|---|--|--|--|---|
| 5 |  PD-A5 x1 |  PD-A30 x1 |  PD-A50 x10 | | | |  CN-A33 |
|---|---|--|---|--|--|--|---|



| | | | | | | | |
|---|---|--|---|--|--|--|---|
| 6 |  PD-A5 x1 |  PD-A32 x1 |  PD-A50 x10 | | | |  CN-A33 |
|---|---|--|---|--|--|--|---|

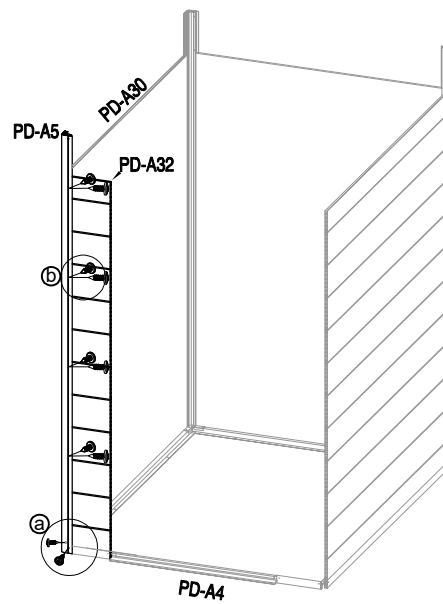
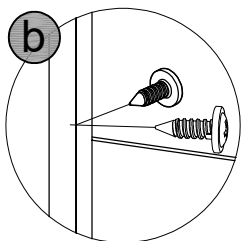
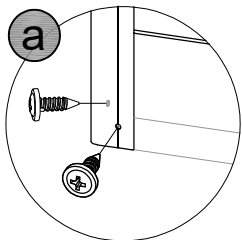
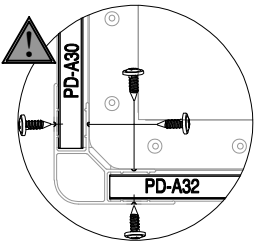

| | | | | | | | |
|---|---|---|---|--|--|--|---|
| 7 |  |  |  | | | |  CN-A33 |
|---|---|---|---|--|--|--|---|

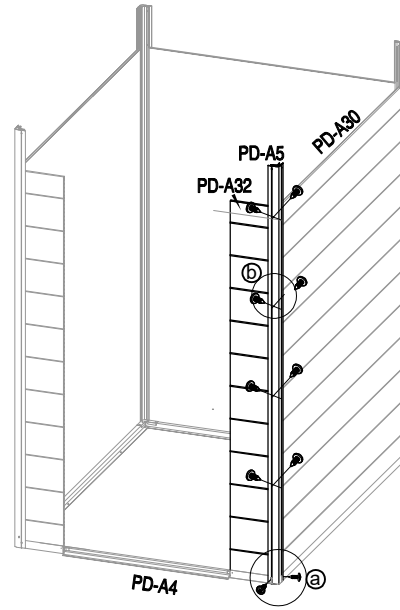
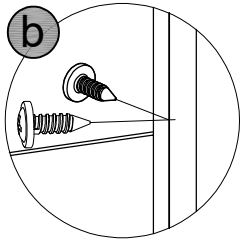
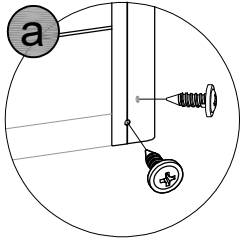
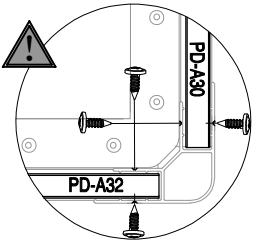

| | | | | | | | |
|---|---|---|---|--|--|--|---|
| 8 |  |  |  | | | |  CN-A33 |
|---|---|---|---|--|--|--|---|

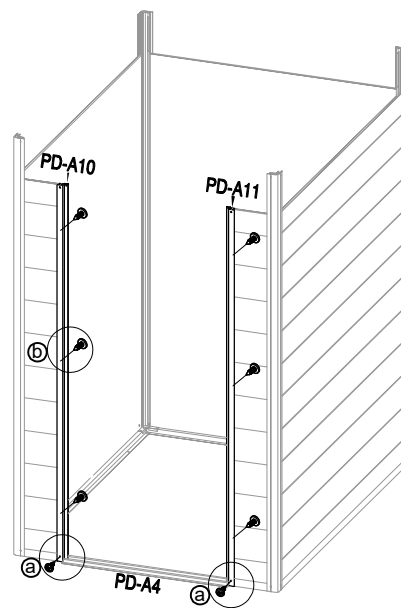
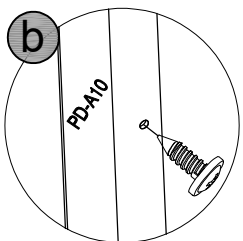
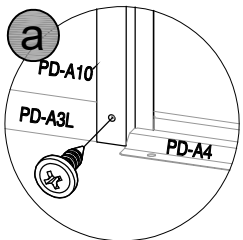
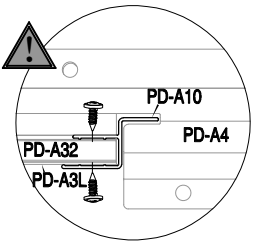

| | | | | | | | |
|---|--|--|--|--|--|--|--|
| 9 |  PD-A20 x2 |  PD-A50 x2 | | | | | |
|---|--|--|--|--|--|--|--|

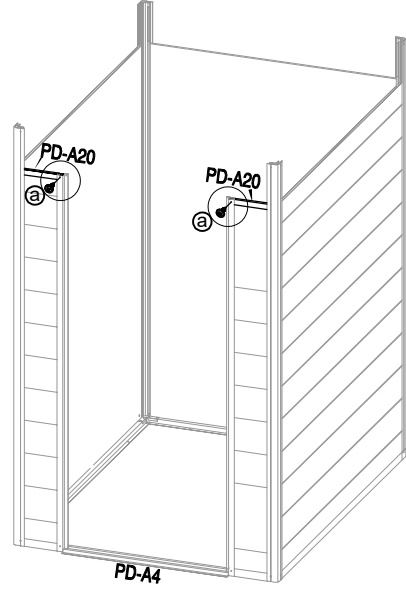
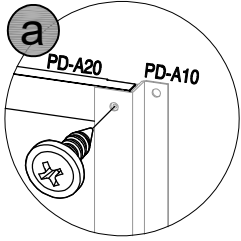

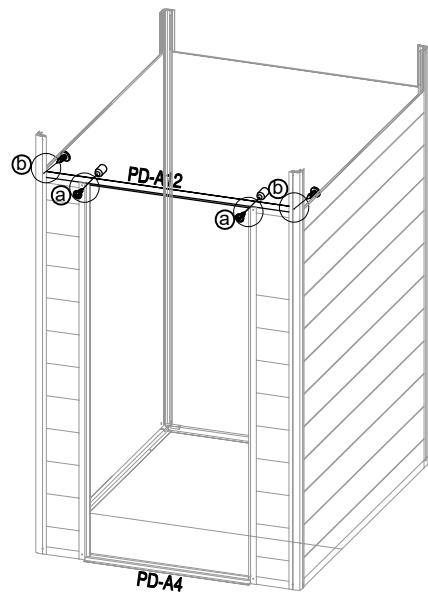
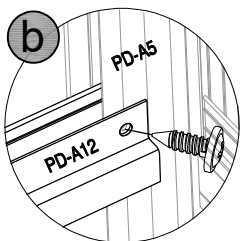
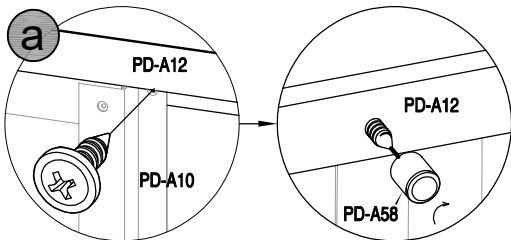
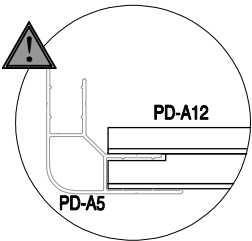

| | | | | | | | |
|----|--|--|--|--|--|--|--|
| 10 |  PD-A12 x1 |  PD-A50 x4 |  PD-A58 x2 | | | | |
|----|--|--|--|--|--|--|--|

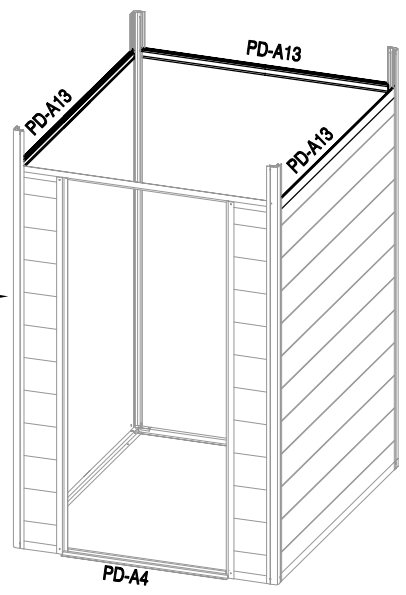
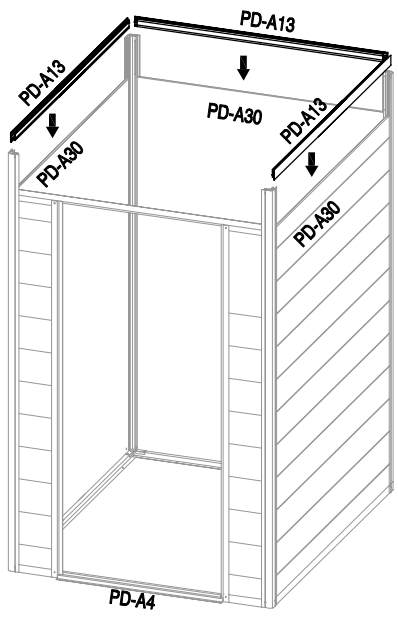
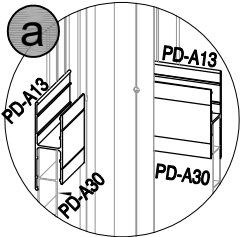
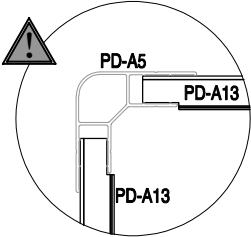

| | | | | | | | |
|-----------|---|--|--|--|--|--|--|
| 11 |  | | | | | | |
| | PD-A13 x3 | | | | | | |





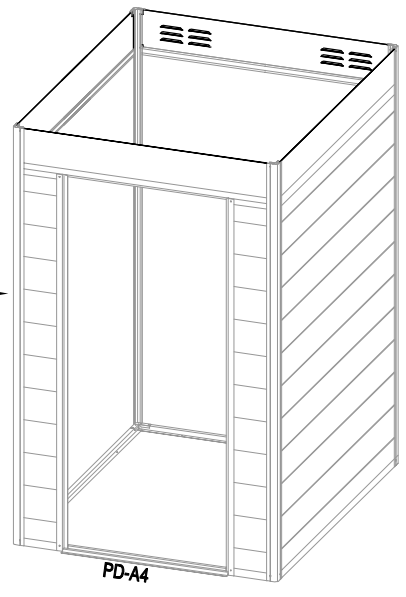
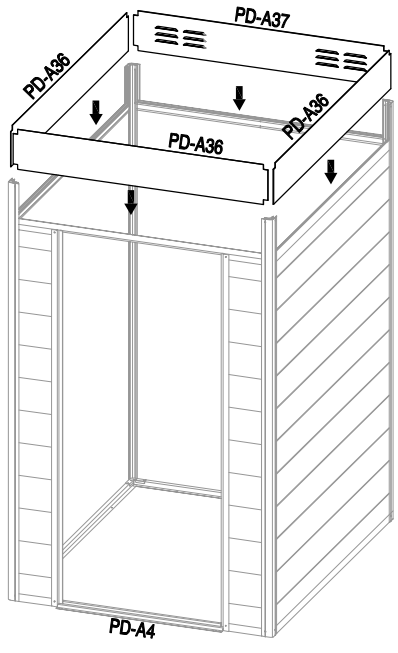
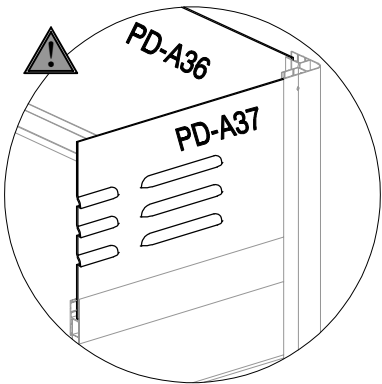

| | | | | | | | |
|-----------|---|---|--|--|--|--|--|
| 12 |  |  | | | | | |
| | PD-A36 x3 | PD-A37 x1 | | | | | |

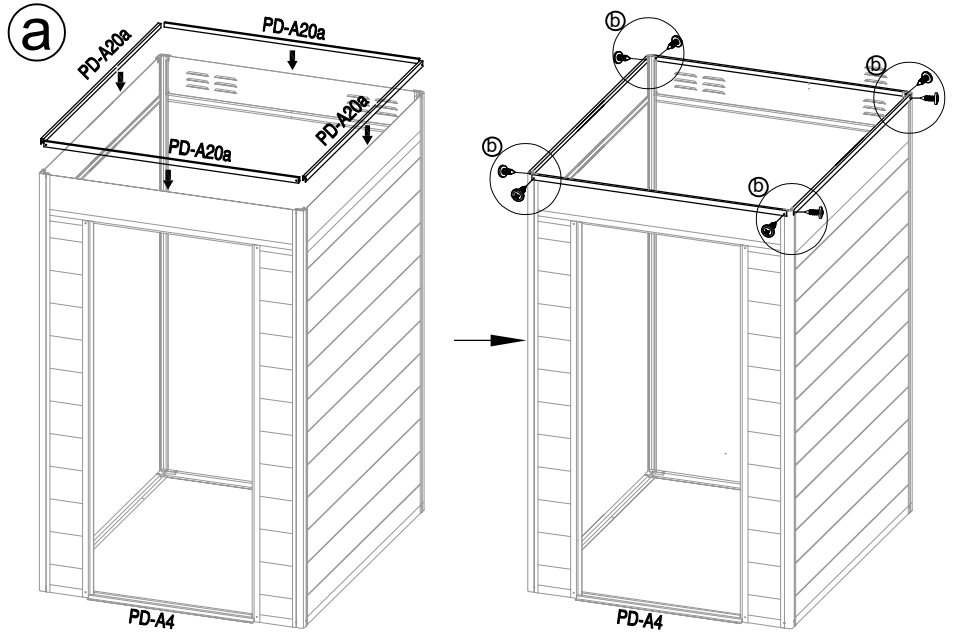
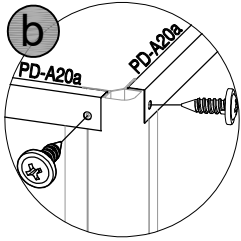
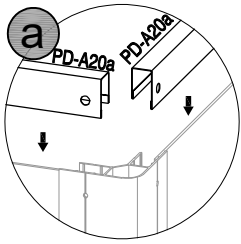

| | | | | | | | |
|-----------|---|--|---|--|--|--|--|
| 13 |  | |  | | | | |
| | PD-A20a x4 | | PD-A50 x8 | | | | |



| | | | | | | | |
|-----------|---|---|---|---|--|--|---|
| 14 |  |  |  |  | | |  |
| | PD-A34 x2 | PD-A35 x1 | PD-A57 x1 | PD-A50 x8 | | | CN-A33 |

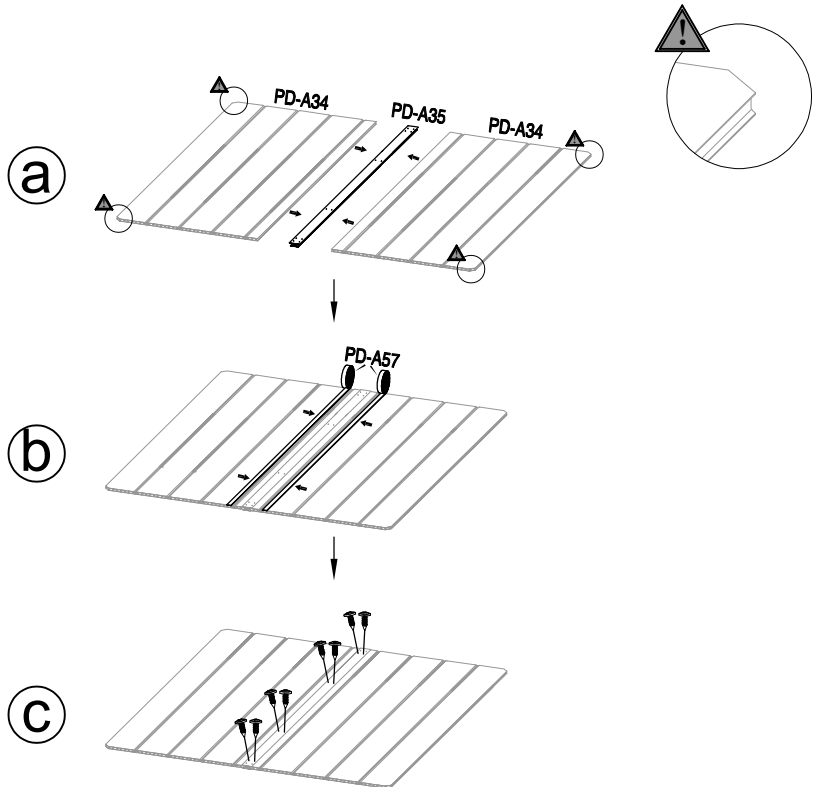
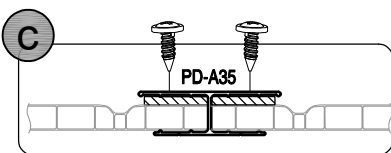
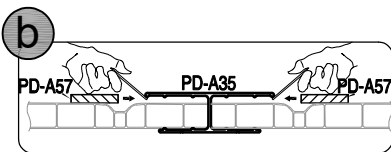
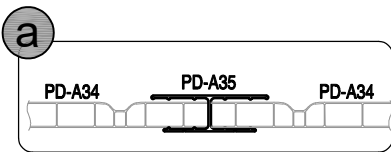

| | | | | | | | |
|----|---|---|--|--|--|--|--|
| 15 |  PD-A18L x1 |  PD-A18R x1 |  M-23 x2 | | | | |
|----|---|---|--|--|--|--|--|

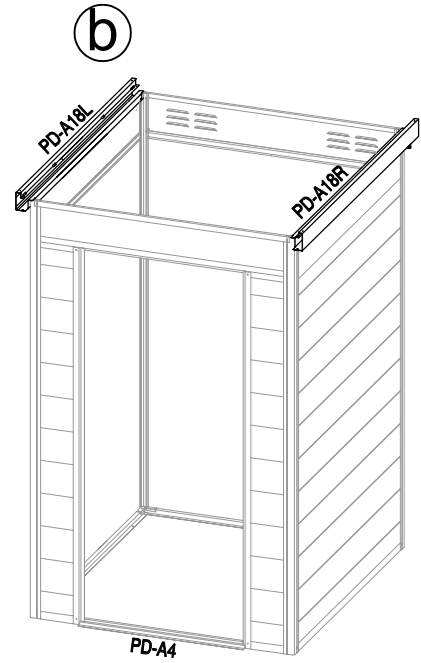
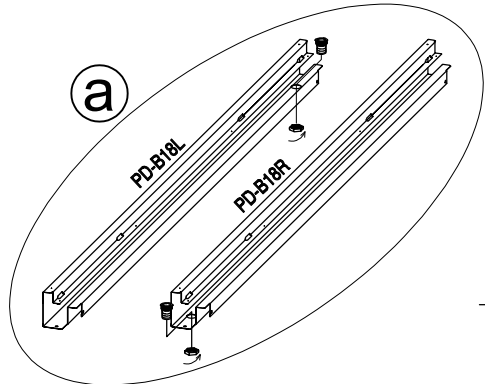
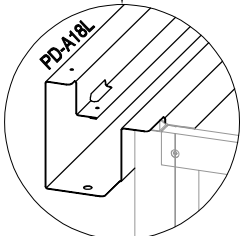
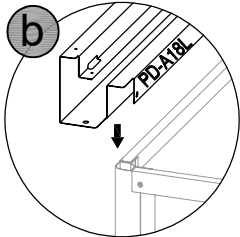
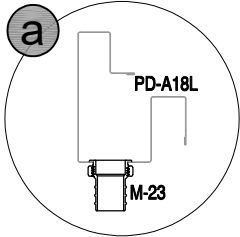

| | | | | | | | |
|----|--|--|--|--|--|--|--|
| 16 |  PD-A17 x1 | | | | | | |
|----|--|--|--|--|--|--|--|

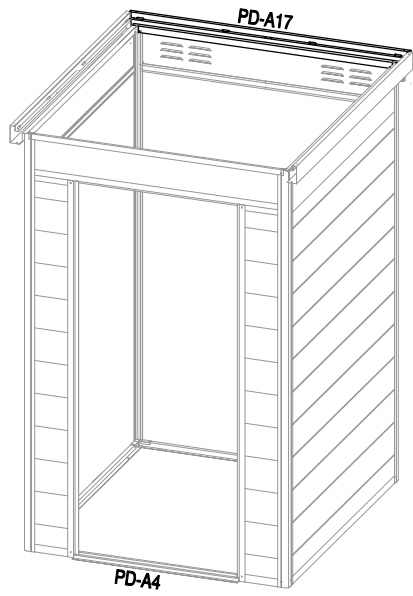
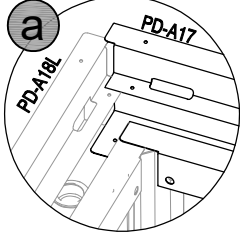

| | | | | | | | |
|-----------|--|--|--|--|--|--|--|
| 17 | | | | | | | |
|-----------|--|--|--|--|--|--|--|

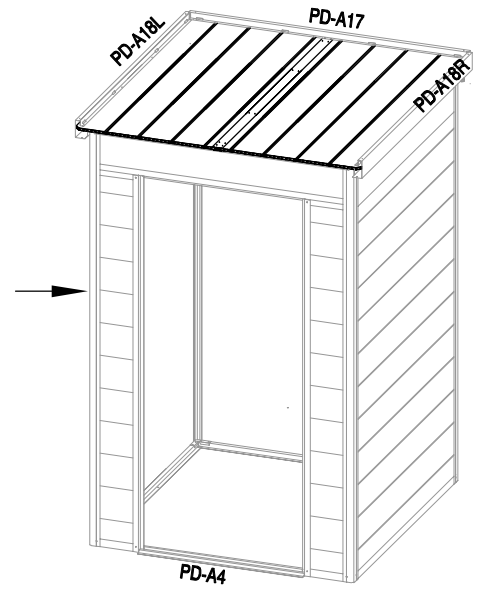
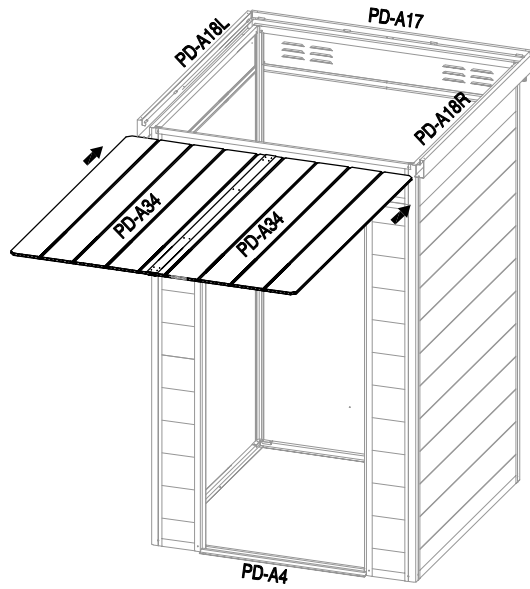
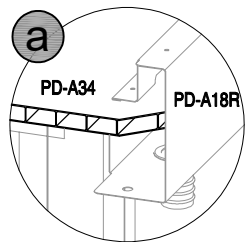
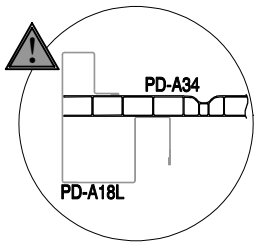

| | | | | | | | |
|-----------|--|--|--|--|--|--|--|
| 18 |  PD-A17 x1 |  PD-A50 x4 | | | | | |
|-----------|--|--|--|--|--|--|--|

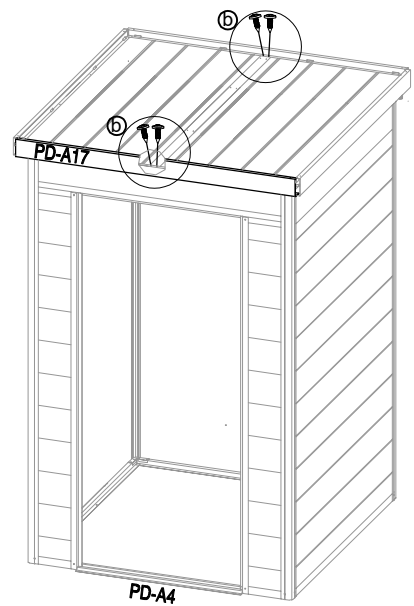
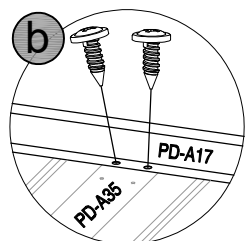
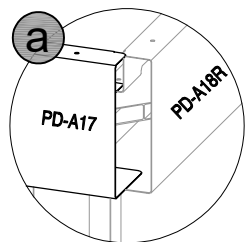

| | | | | | | | |
|----|--|--|--|--|--|--|--|
| 19 |  PD-A50 x8 | | | | | | |
|----|--|--|--|--|--|--|--|

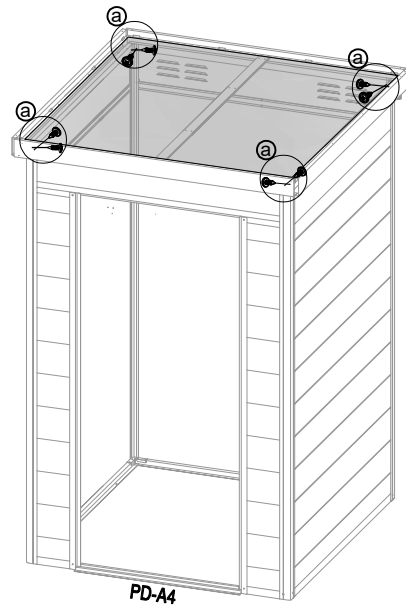
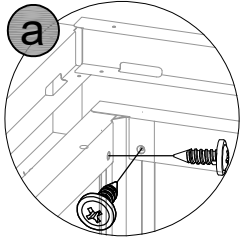



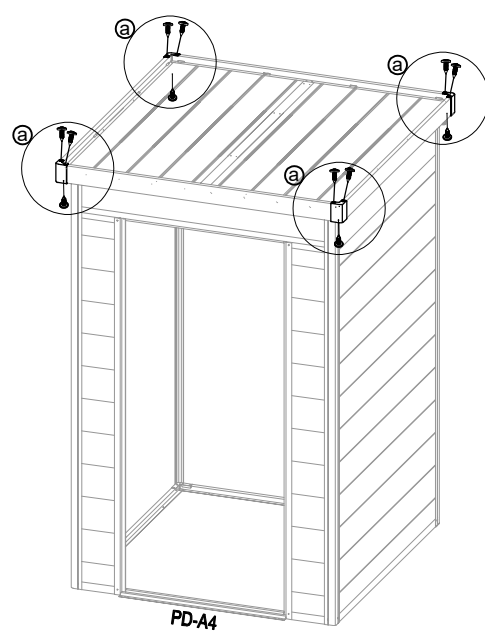
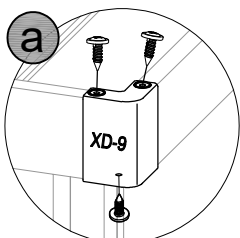

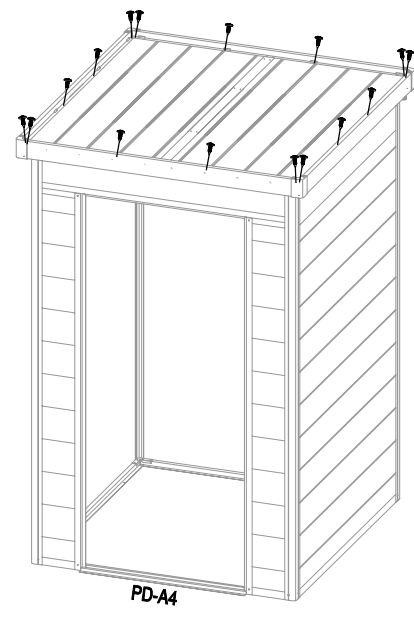
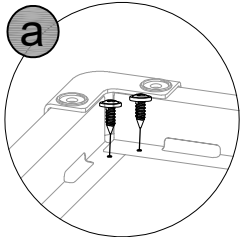
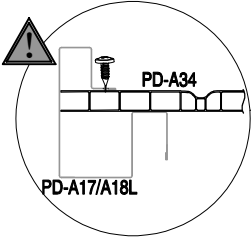

| | | | | | | | |
|----|--|---|--|--|--|--|--|
| 20 |  XD-9 x4 |  PD-A50 x12 | | | | | |
|----|--|---|--|--|--|--|--|



| | | | | | | | |
|-----------|---|--|--|--|--|--|--|
| 21 |  | | | | | | |
| | PD-A50 x16 | | | | | | |

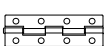



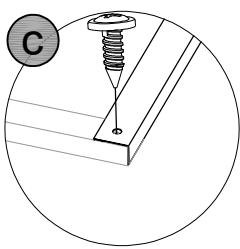
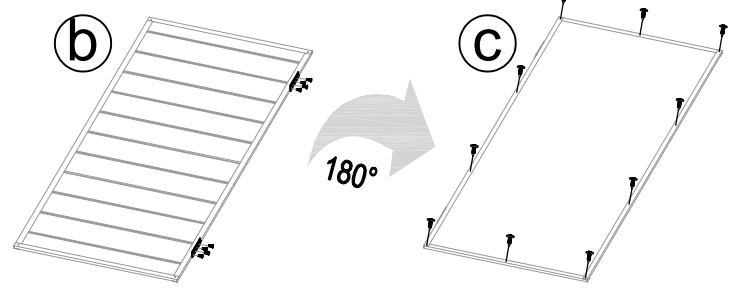
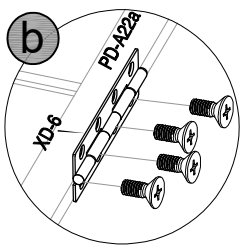
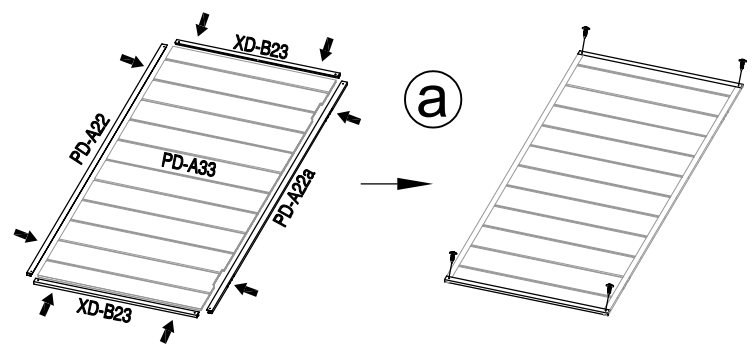
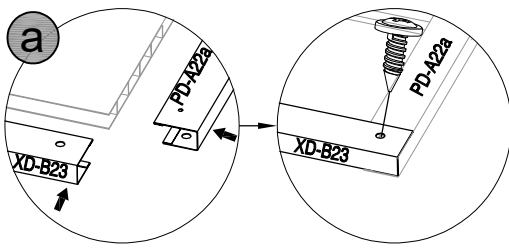

| | | | | | | | |
|-----------|---|---|---|---|--|---|---|
| 22 |  |  |  |  |  |  |  |
| | PD-A33 x1 | PD-A22 x1 | PD-A22a x1 | XD-B23 x2 | XD-6 x2 | PD-A50 x14 | PD-A53 x8 |

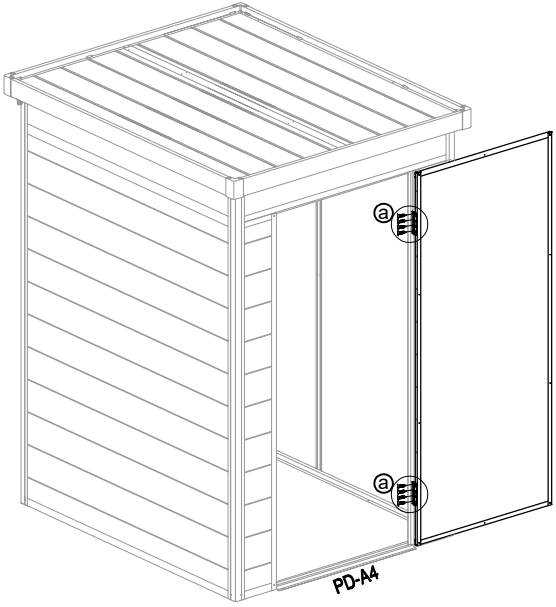
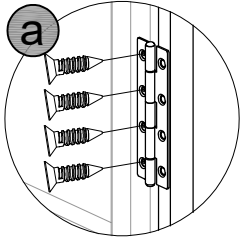

| | | | | | | | |
|----|--|--|--|--|--|--|--|
| 23 |  PD-A54 x8 | | | | | | |
|----|--|--|--|--|--|--|--|



| | | | | | | | |
|----|--|--|--|--|--|--|--|
| 24 |  XD-5 x1 |  PA01 x3 |  PD-A51 x3 |  PD-A52 x2 | | | |
|----|--|--|--|--|--|--|--|

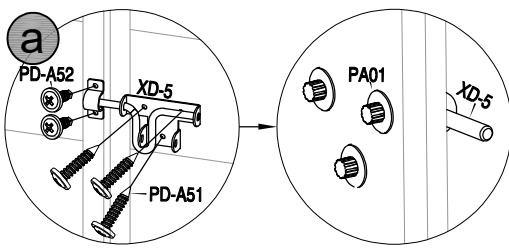
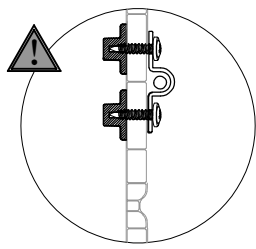

| | | | | | | | |
|----|---|--|--|--|--|--|--|
| 25 |  PD-10 x1 | | | | | | |
|----|---|--|--|--|--|--|--|

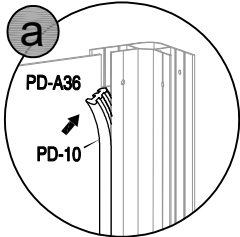
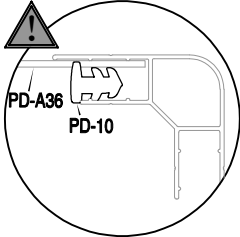

| | | | | | | | |
|----|---|--|--|--|--|--|--|
| 26 |  PD-A55 x10 | | | | | | |
|----|---|--|--|--|--|--|--|

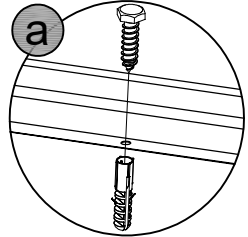
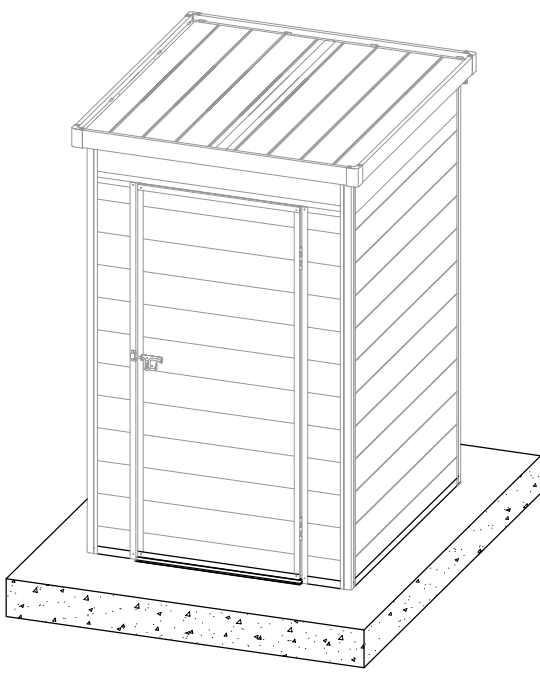

Warning icon: exclamation mark in a triangle. A=B

