

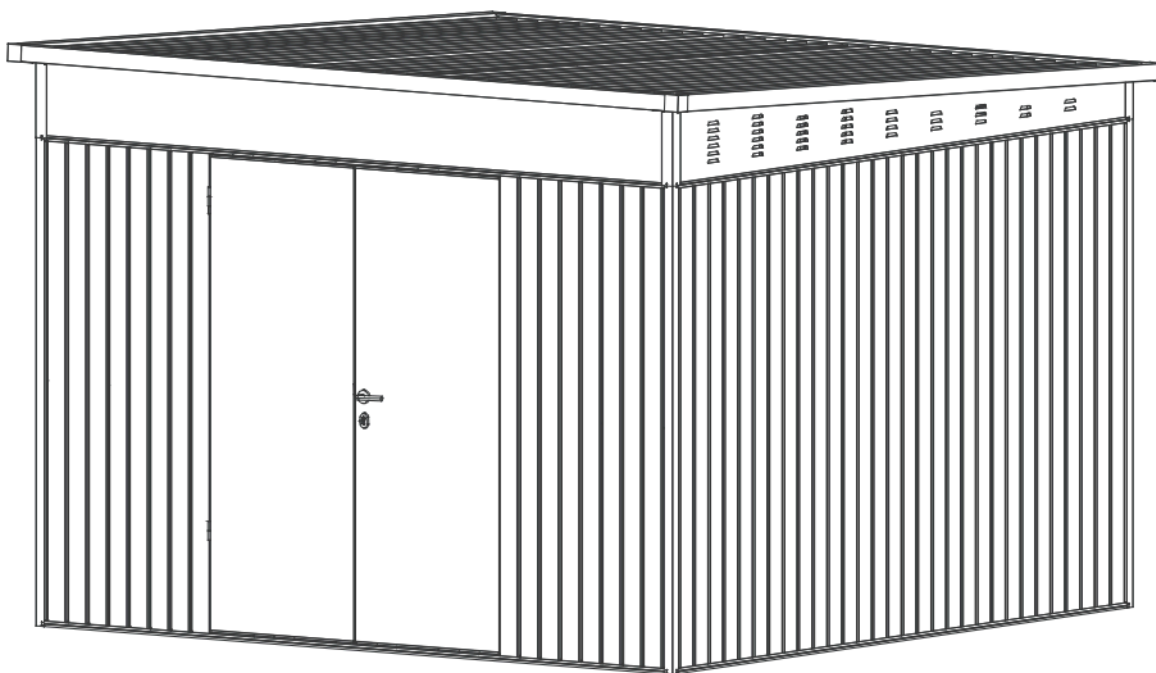

Abri Métal TECHPROTECT® 9,60 Monopente

Référence 3760055274340



Notice à conserver et à consulter attentivement avant montage. Porter les protections appropriées

Pour tout contact en cas de besoin:

sav@green-outside.com

Green Outside sas, 21 route d'Alex, 01100 Bellignat



vs 12-2024



Photos non contractuelles – Ne pas jeter sur la voie publique



Informations pour le montage



IMPORTANT

ETAPES DE MONTAGE

Assemblez l'abris en suivant les instructions et les schémas fournis dans le manuel.

Lors de son installation, assurez-vous d'avoir suffisamment d'espace pour vous déplacer dans toutes les directions.

Avant l'assemblage, familiarisez-vous avec les pièces individuelles illustrées.

Avant de commencer l'assemblage, retirez le film de protection en plastique de tous les composants. Une fois installé, il est difficile de le retirer.

Réaliser le montage avec au moins 3 personnes.

Pour le montage il vous faut : (Non inclus !)

- un ruban à mesurer
- un niveau à bulle
- une échelle
- une pince universelle
- une visseuse sans fil et une perceuse Vis/chevilles/angles pour la fixation à la fondation

Lisez et conservez les instructions de montage.

Ces instructions de montage appartiennent à l'abris.

Ce document contient des informations importantes sur le montage et l'utilisation. Lisez attentivement les instructions de montage, en particulier les instructions de sécurité, avant d'assembler et d'utiliser l'abris à outils. Le non-respect de ces instructions de montage peut entraîner des blessures graves ou des dommages à l'abris à outils.

Veuillez conserver les instructions de montage pour une utilisation ultérieure. Si vous cédez l'abris à des tiers, assurez-vous d'inclure ces instructions de montage.

Consignes de sécurité

Risque d'explosion !

L'abris peut devenir très chaud à cause du soleil. Les explosifs peuvent exploser et sont inflammables/combustibles.

Les matériaux peuvent s'enflammer s'ils sont stockés dans l'abris de jardin. Ne stockez jamais de produits chimiques pour votre piscine dans l'abris de jardin ! Les matières inflammables et corrosives doivent être entreposées dans des contenants hermétiques et homologués. Ne stockez aucune substance inflammable, combustible ou explosive dans l'abris de jardin. Si un incendie éclate dans l'abris à outils, appelez immédiatement le service d'incendie et assurez-vous que personne ne se trouve à proximité. abri de jardin.

Attention!

Danger pour les enfants et les personnes ayant des capacités physiques, sensorielles ou mentales réduites (personnes partiellement handicapées, personnes âgées aux capacités physiques et mentales réduites) ou manquant d'expérience et de connaissances (par exemple enfants plus âgés). Tenir les jeunes enfants éloignés de toutes les pièces d'assemblage et de l'assemblage. emplacement.indre des niveaux très élevés en été !

Ne laissez pas les enfants jouer avec le film d'emballage. Les enfants peuvent s'y coincer pendant qu'ils jouent et s'étouffer. Assurez-vous que les enfants ne mettent pas de petites pièces telles que des vis dans leur bouche, car ils pourraient les avaler et s'étouffer avec elles.

Ne laissez pas les enfants grimper ou jouer avec l'abris. Gardez les enfants et les personnes ayant des capacités physiques, sensorielles ou mentales réduites à l'écart de l'abris pendant l'assemblage. Ne laissez pas les enfants ou les personnes aux capacités physiques, sensorielles ou mentales réduites assembler, nettoyer, entretenir ou réparer l'abris.

Risques de dommages!

Une mauvaise manipulation de l'abris peut entraîner des blessures. Fermez les portes et les fenêtres en cas de vent et de tempête. Dégagez la neige et de la glace. N'entrez pas dans l'abris si des pièces sont endommagées ou déformées. Remplacez les pièces endommagées uniquement par des pièces de rechange d'origine appropriées.

Ne regroupez pas plusieurs abris en un seul endroit. Pour éviter le vol, nous vous recommandons de toujours verrouiller la remise à outils lorsque vous partez. Une serrure de porte est incluse.

En cas de doute, vous pouvez nous contacter sur l'adresse mail sav@green-outside.com (apporter un maximum de précisions, photos etc... pour un retour rapide)

Composants structure

(à vérifier avant montage)

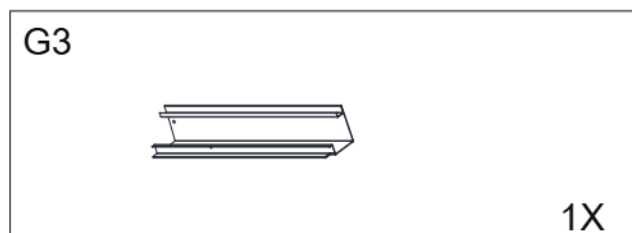
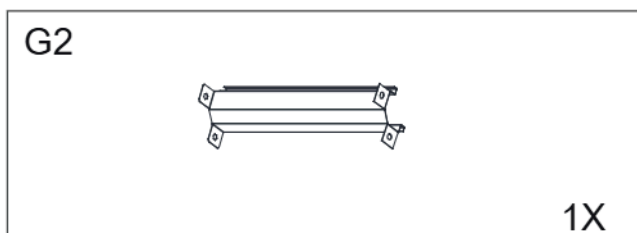
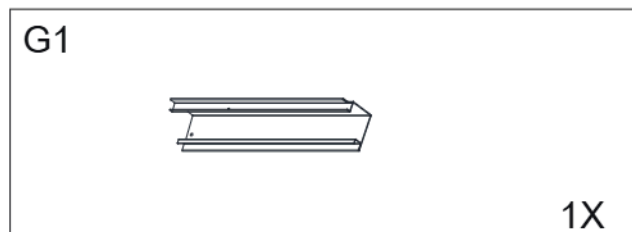
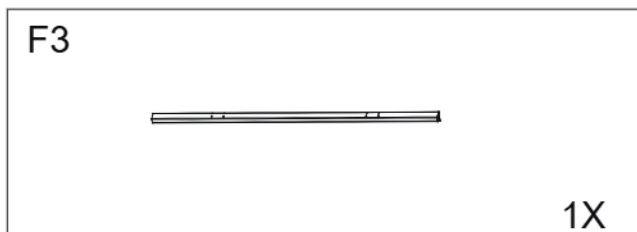
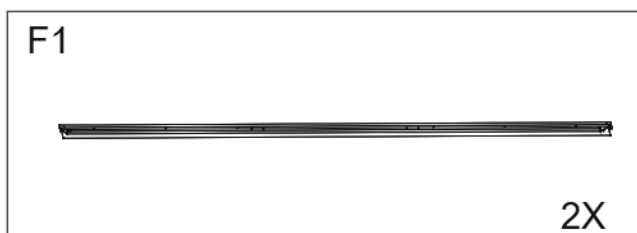
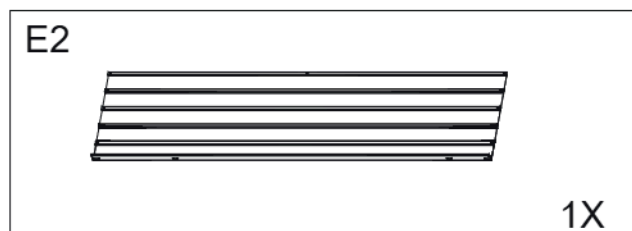
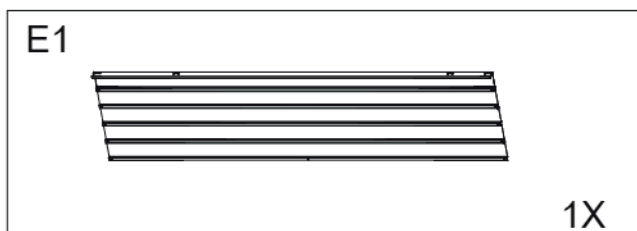
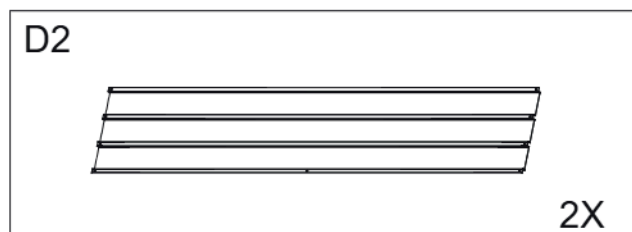
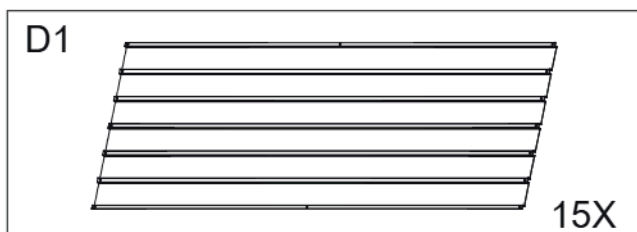
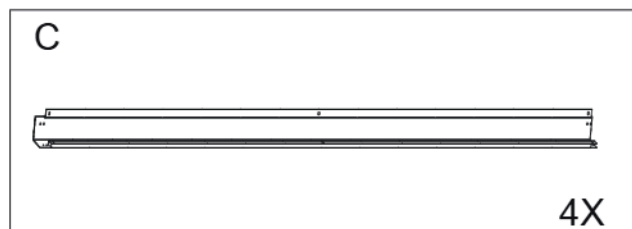
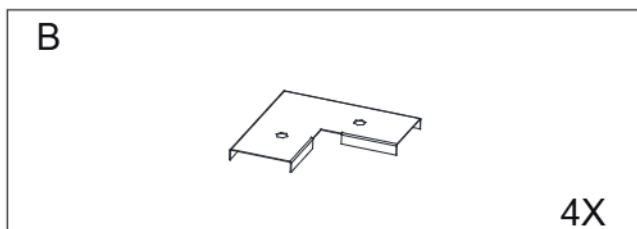
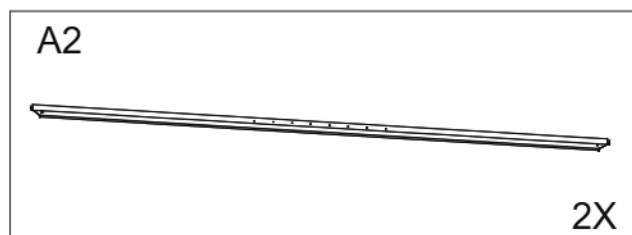
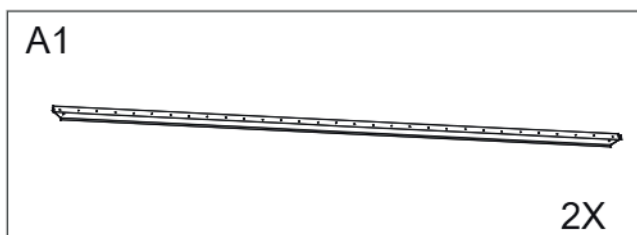

Composants structure

(à vérifier avant montage)

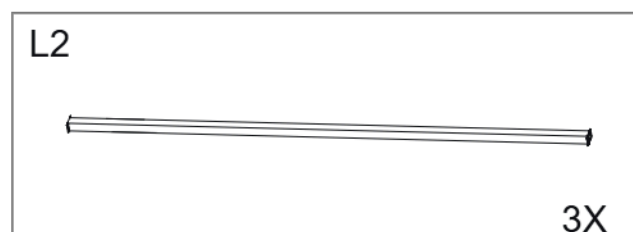
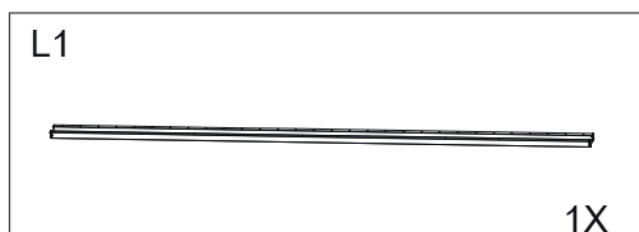
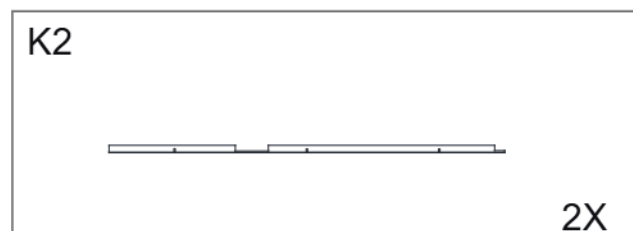
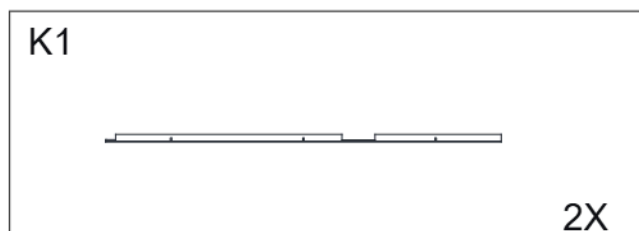
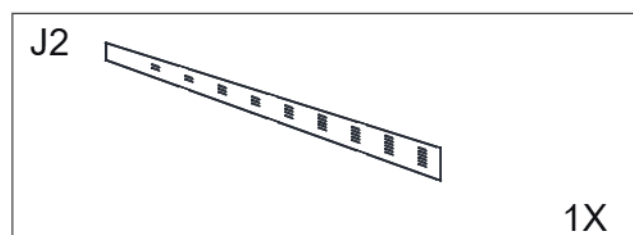
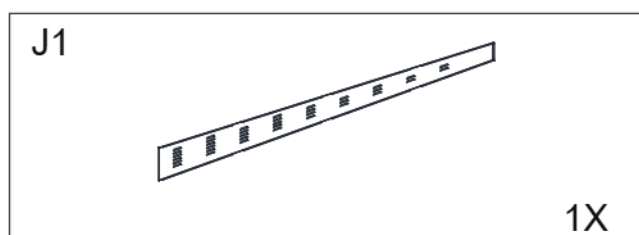
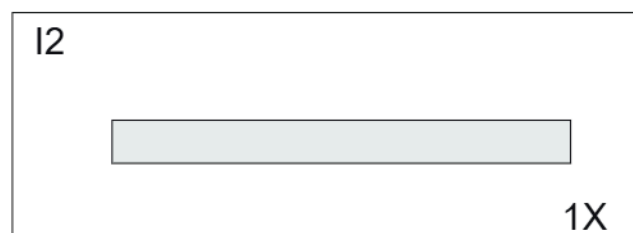
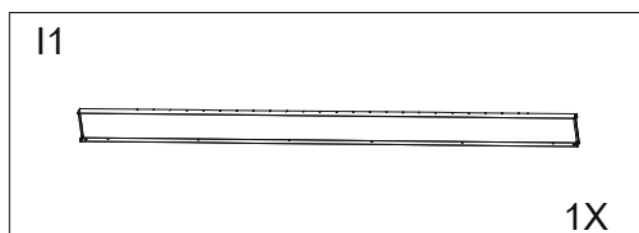
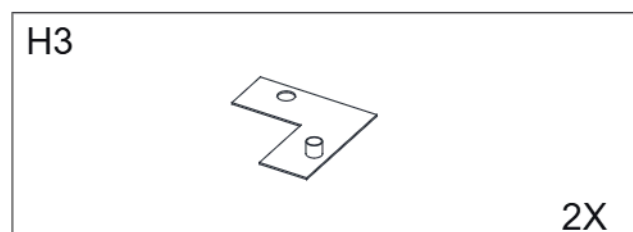
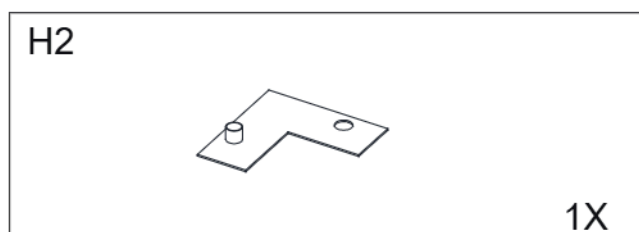
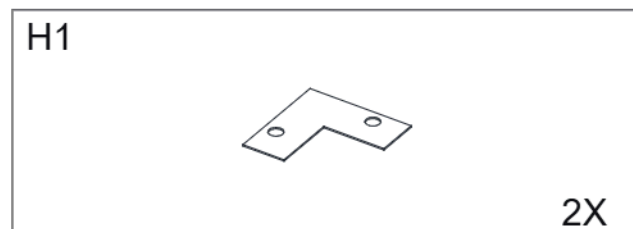
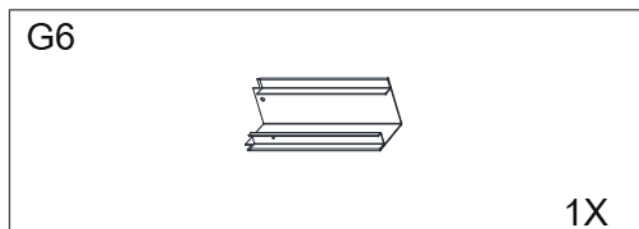
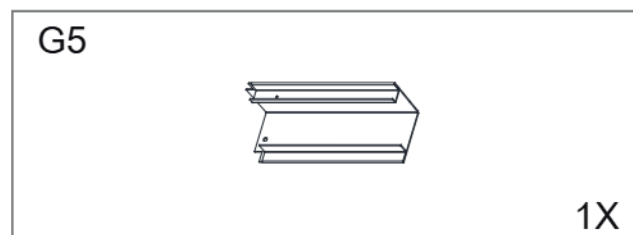
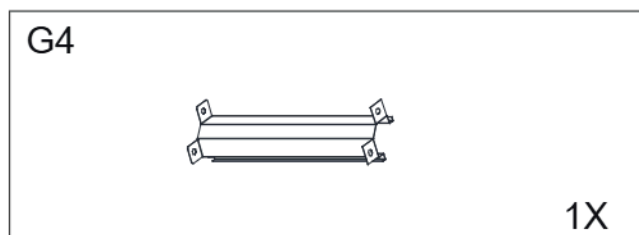

Composants structure

(à vérifier avant montage)

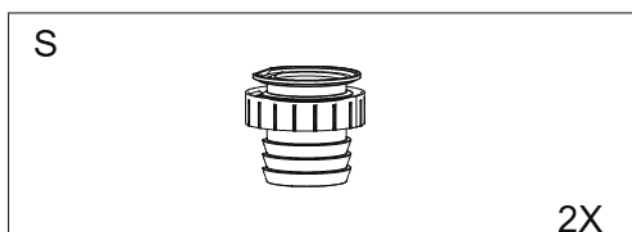
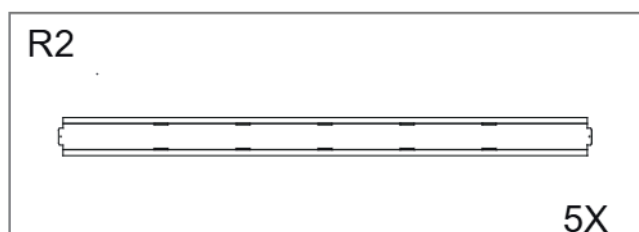
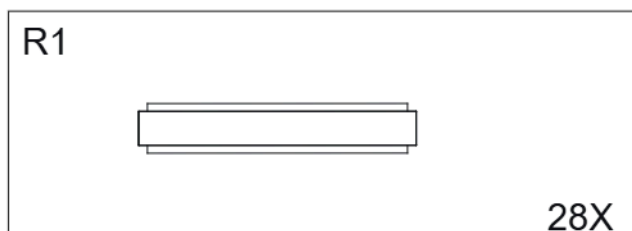
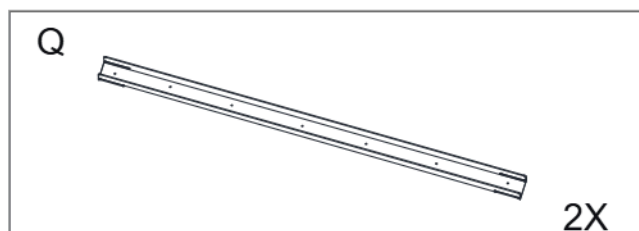
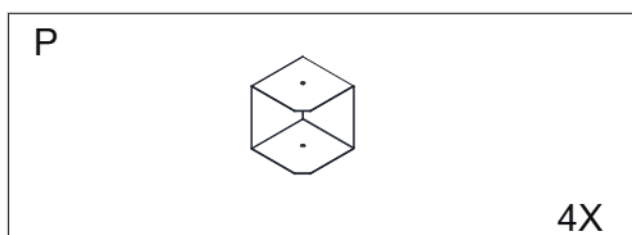
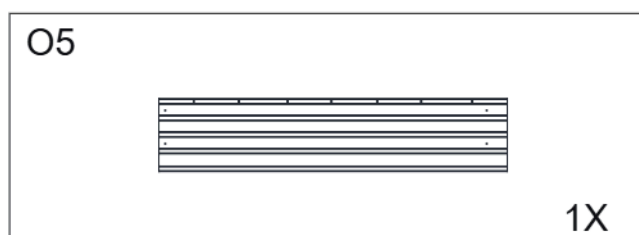
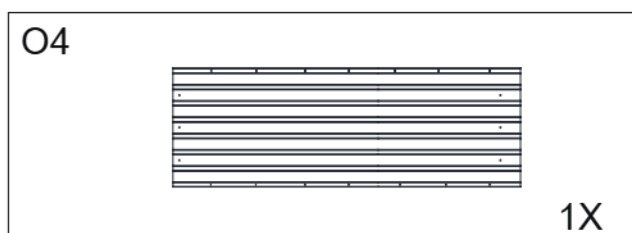
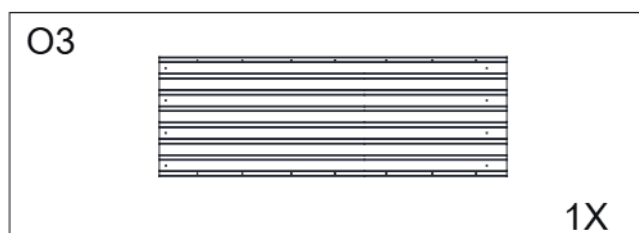
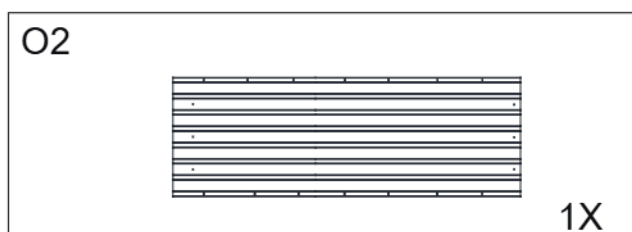
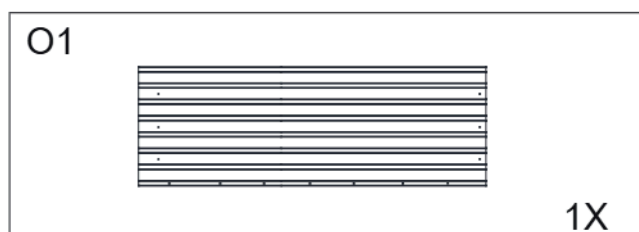
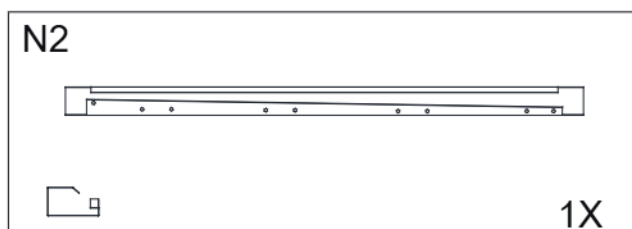
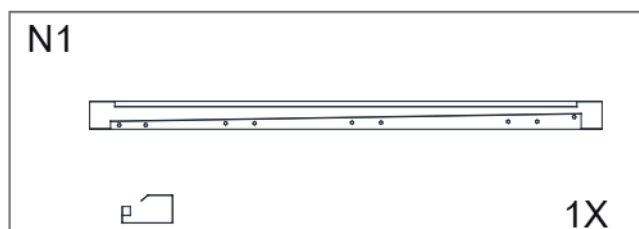
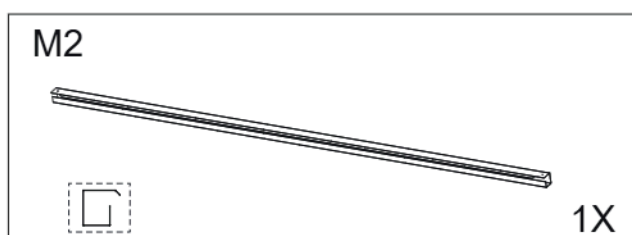
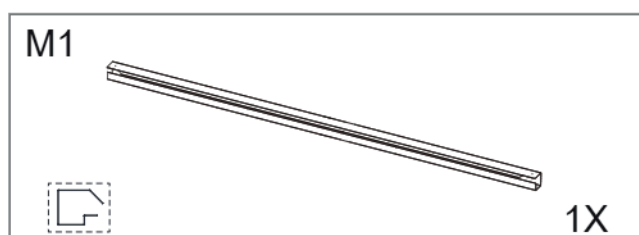





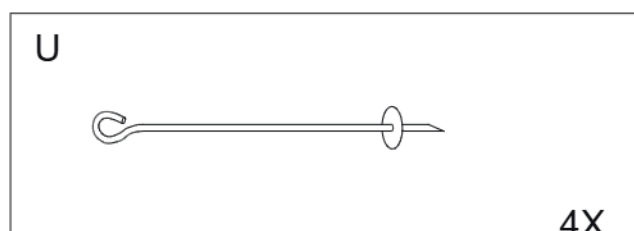
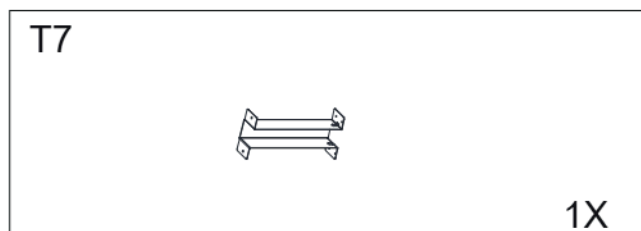
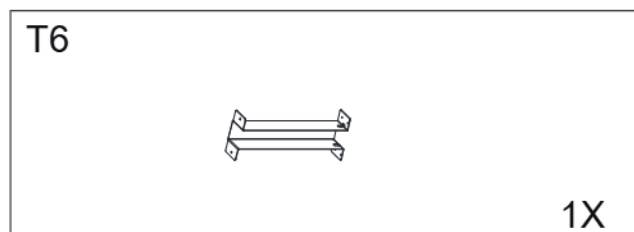
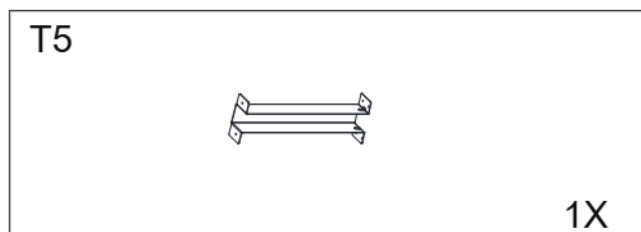
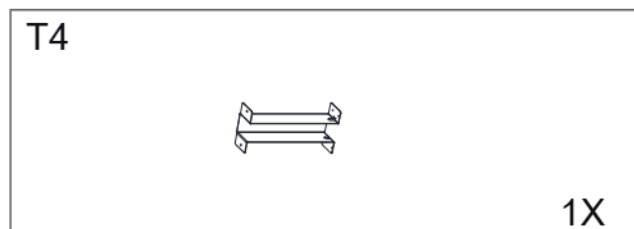
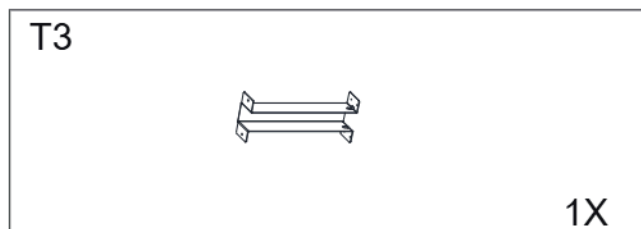
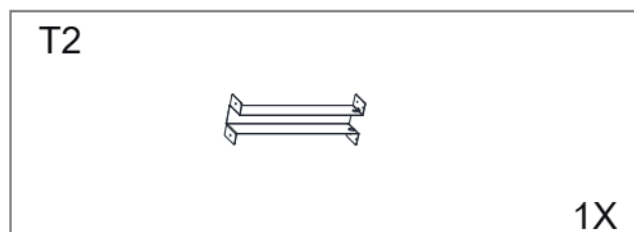
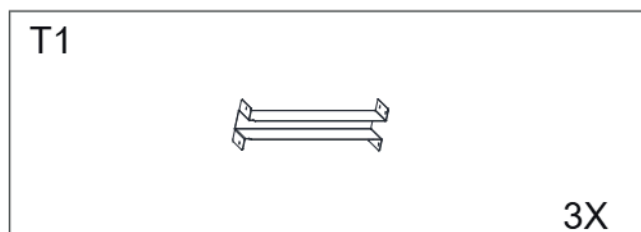



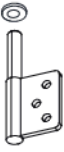

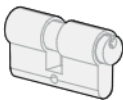
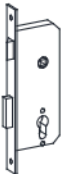
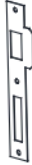
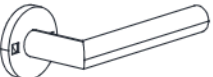

Composants structure





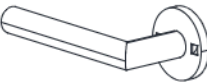





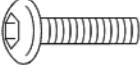

(à vérifier avant montage)

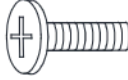

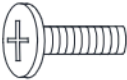
Pièces de la porte

X1  2X	X2  2X	X3  4X
X4  1X	X5  1X	X6  1X
Y1  1X	Y2  1X	Y3  2X
Y4  2X	Y5  2X	Y6  M5*35 2X
Y7  M5*50 1X	Y8  2X	Y9  1X
Z1  1X	Z2  1X	

VISSERIE

AA M5*10  60X	BB M4*12  428X	CC  378X
DD M5  308X	EE M5*10  3X	FF M5  66X
GG M4*10  12X	HH M5  25X	JJ M4*20  6X
KK  1X	LL  1X	MM  3# 1X
II 4#  1X		

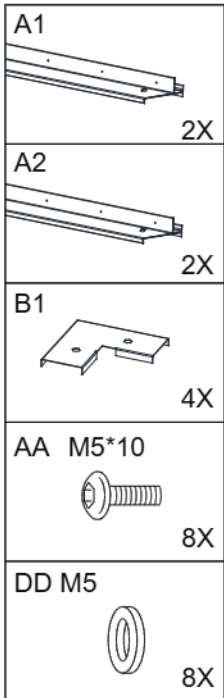

1. Assembler le châssis au sol

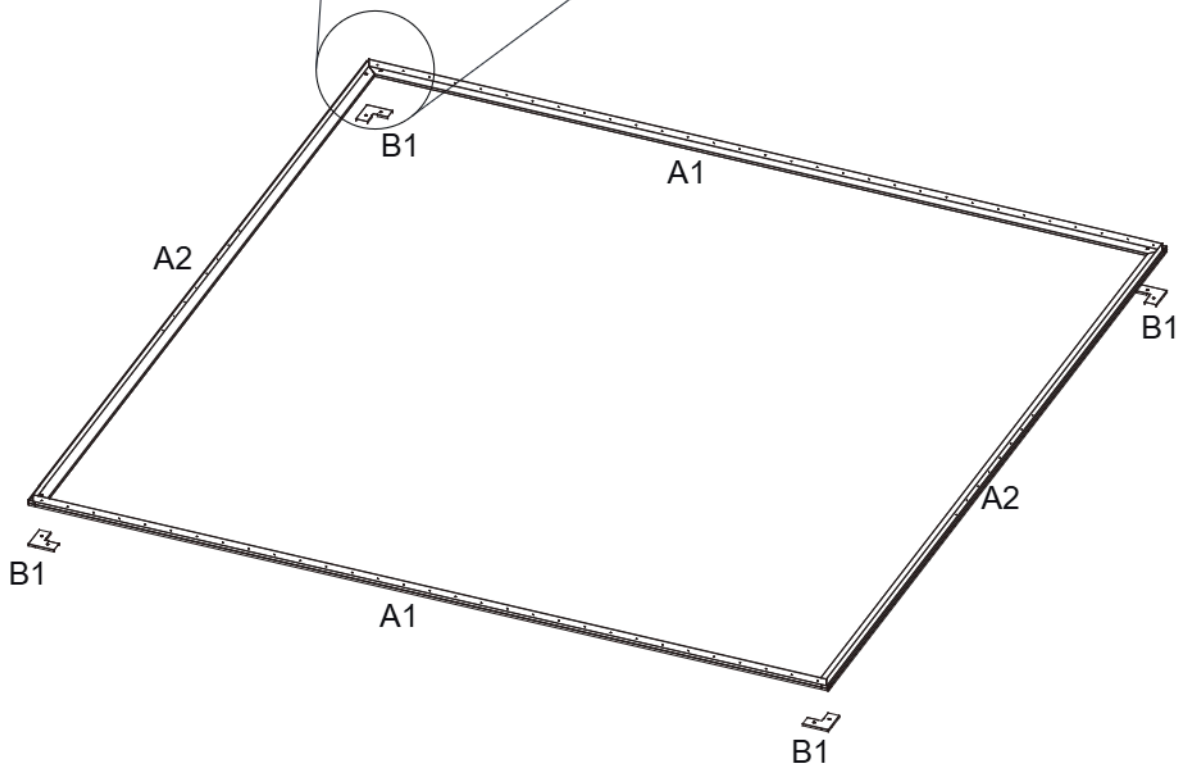
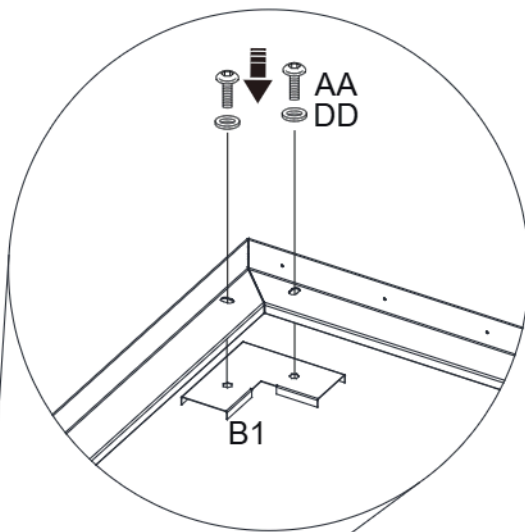

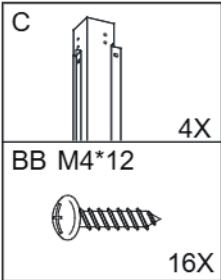



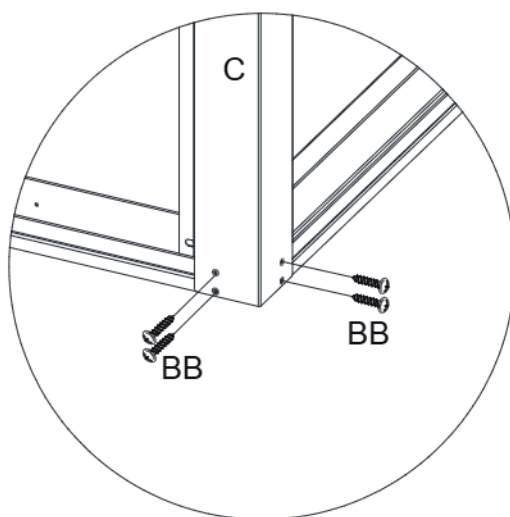
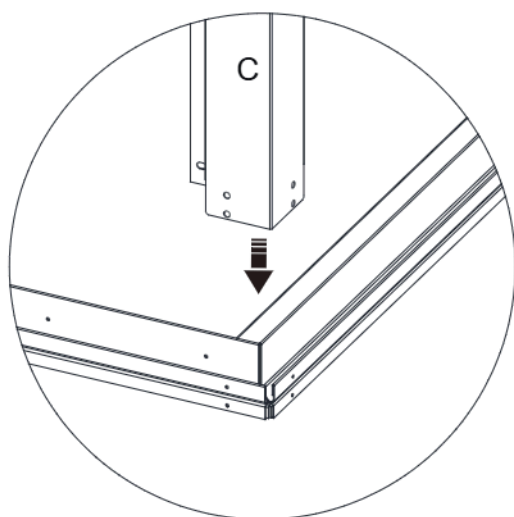
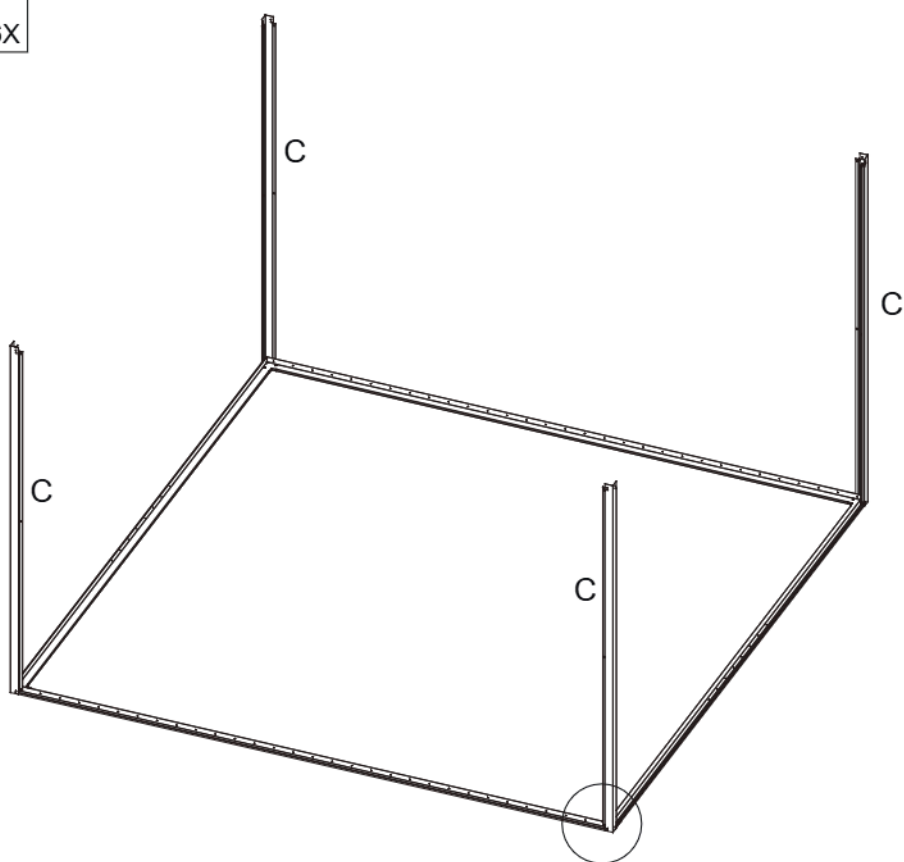









2. Assembler les poteaux.

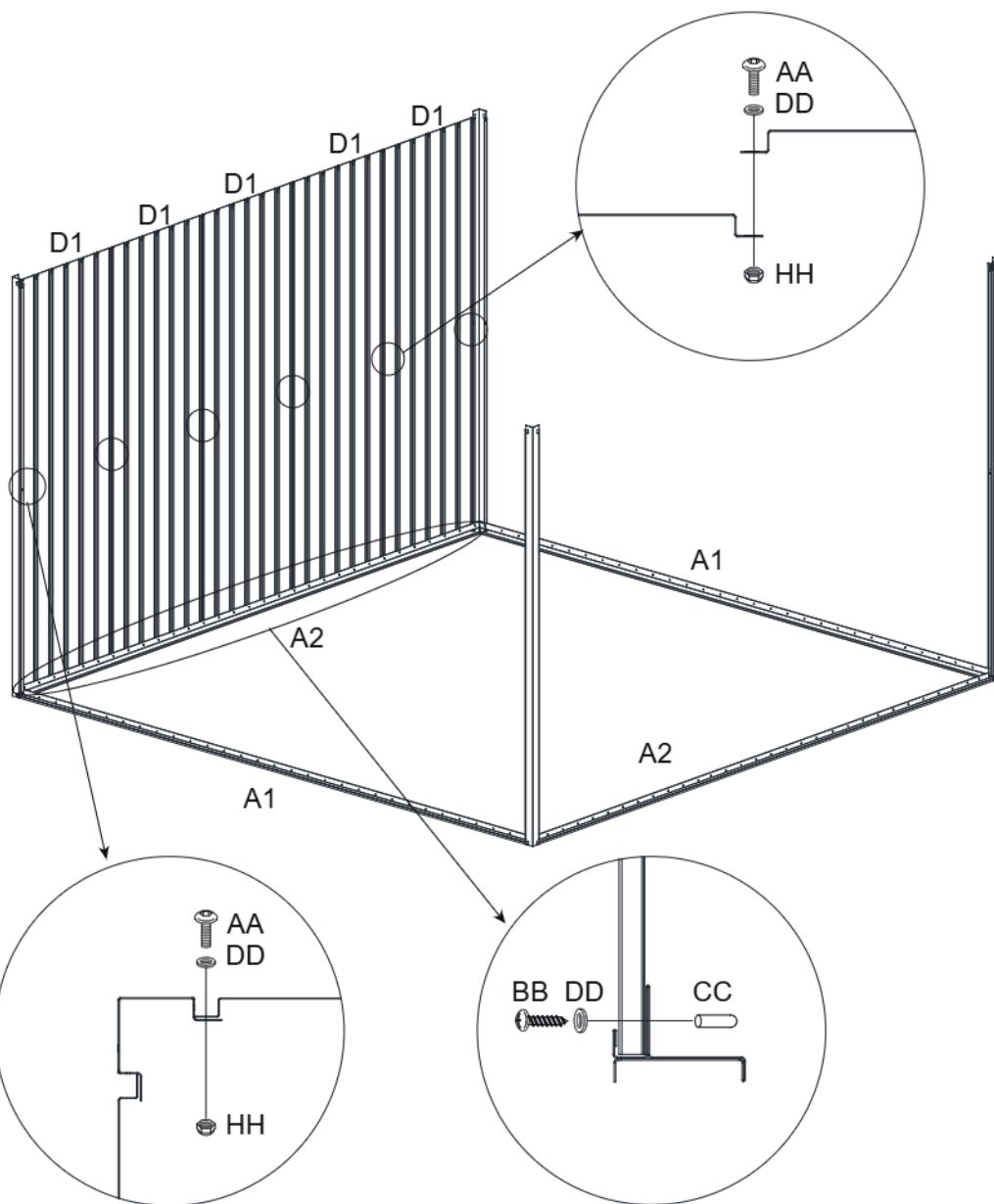

3.Assembler les murs.

D1		5X
BB M4*12		31X
CC		31X
AA M5*10		6X
DD M5		37X
HH M5		6X



D1		5X
BB M4*12		31X
CC		31X
AA M5*10		6X
DD M5		37X
HH M5		6X



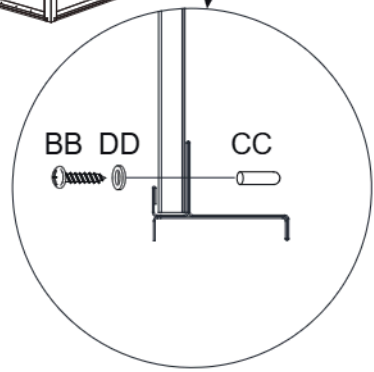
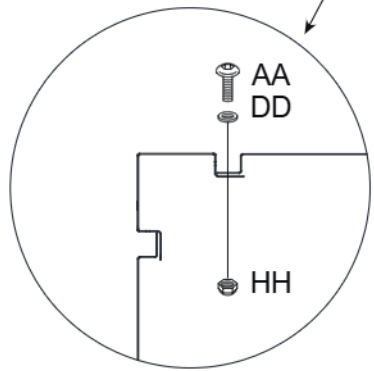
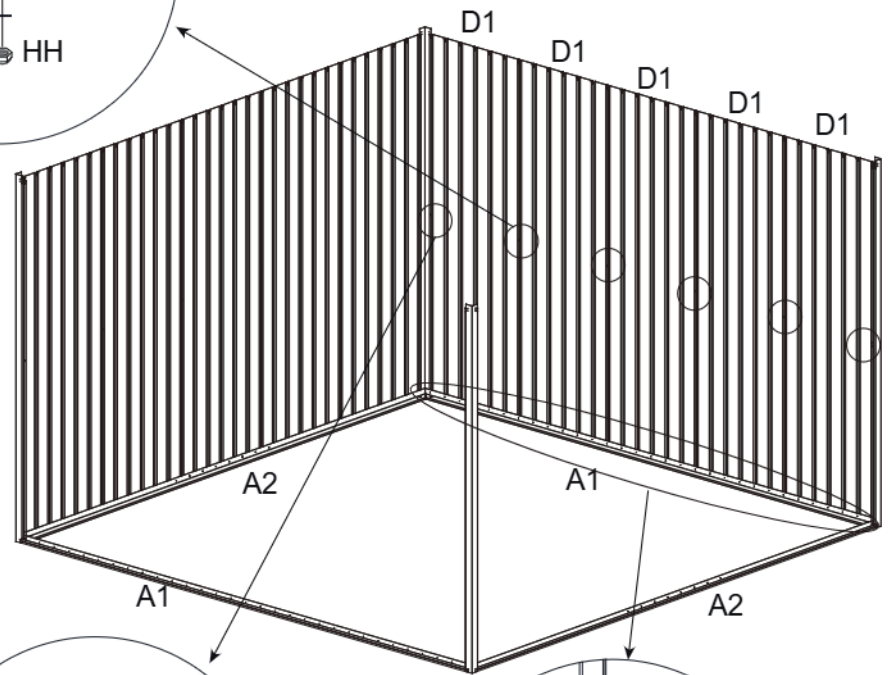
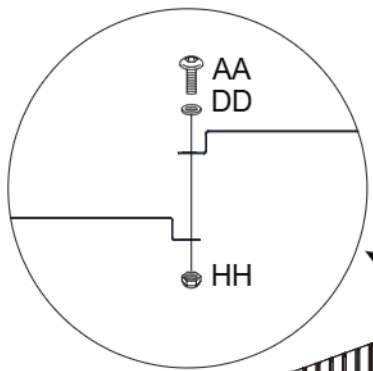

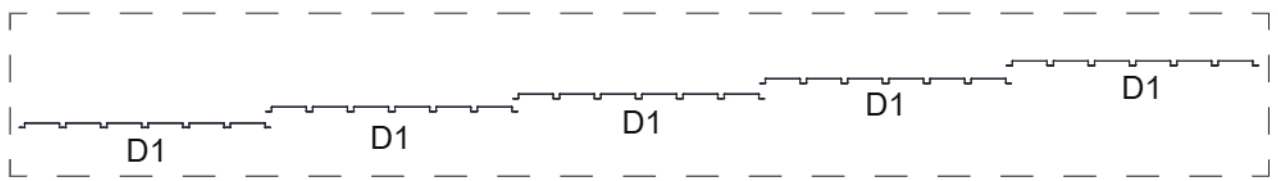

4.Assembler les murs II.









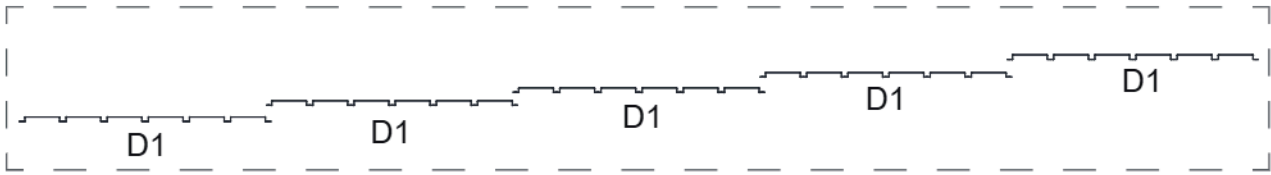
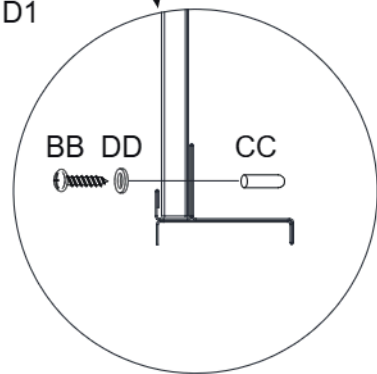
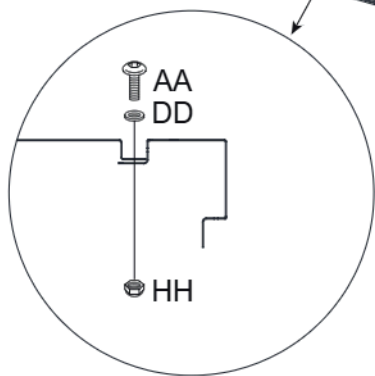
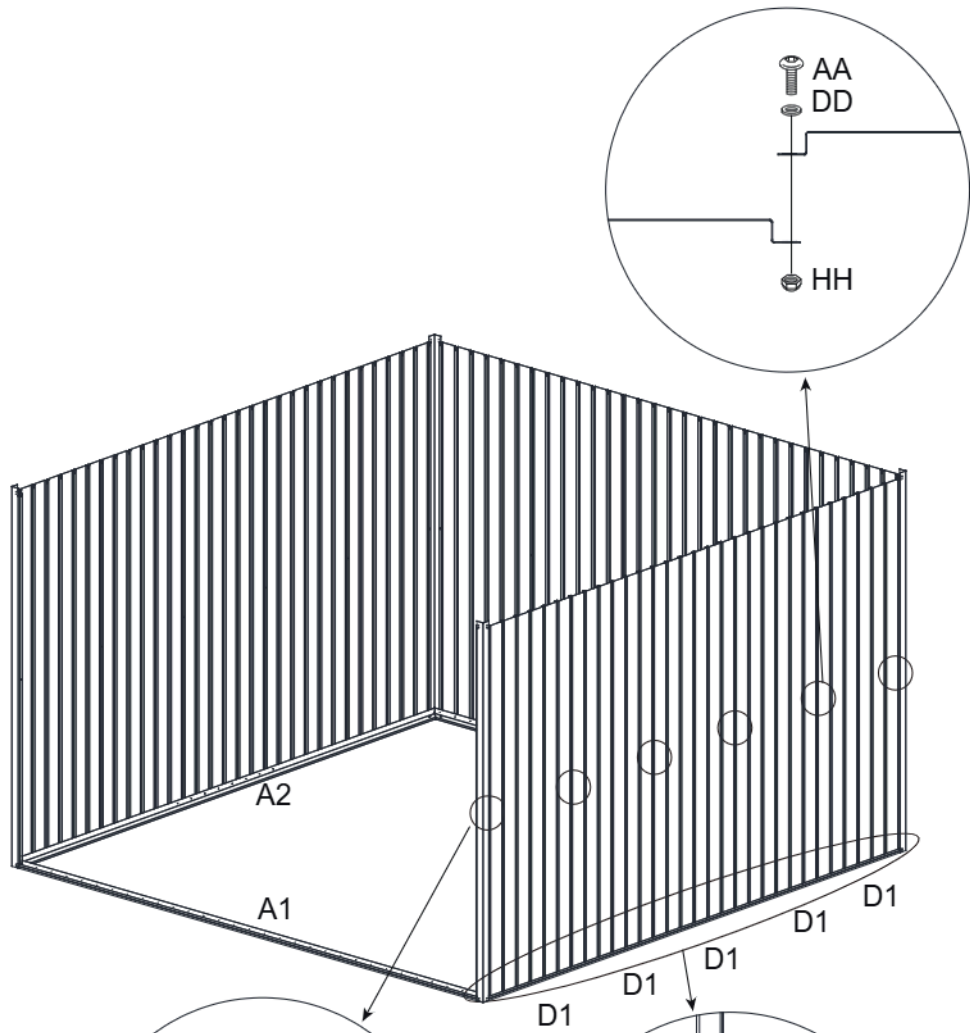

6



5.Assembler les murs III.

- D1  5X
- BB M4*12  31X
- CC  31X
- AA M5*10  6X
- DD M5  37X
- HH M5  6X



D2		2X
BB M4*12		16X
CC		16X
AA M5*10		4X
DD M5		20X
HH M5		4X
E1		1X
E2		1X

6.Assembler les deux côtés de la porte.

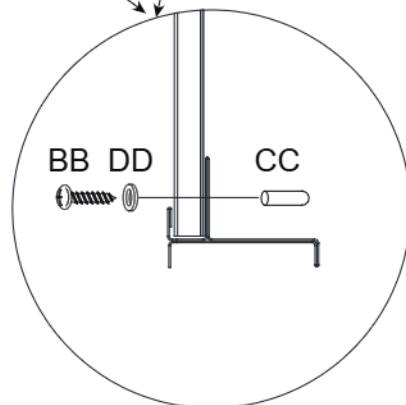
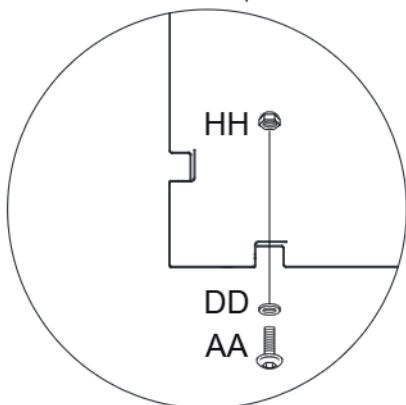
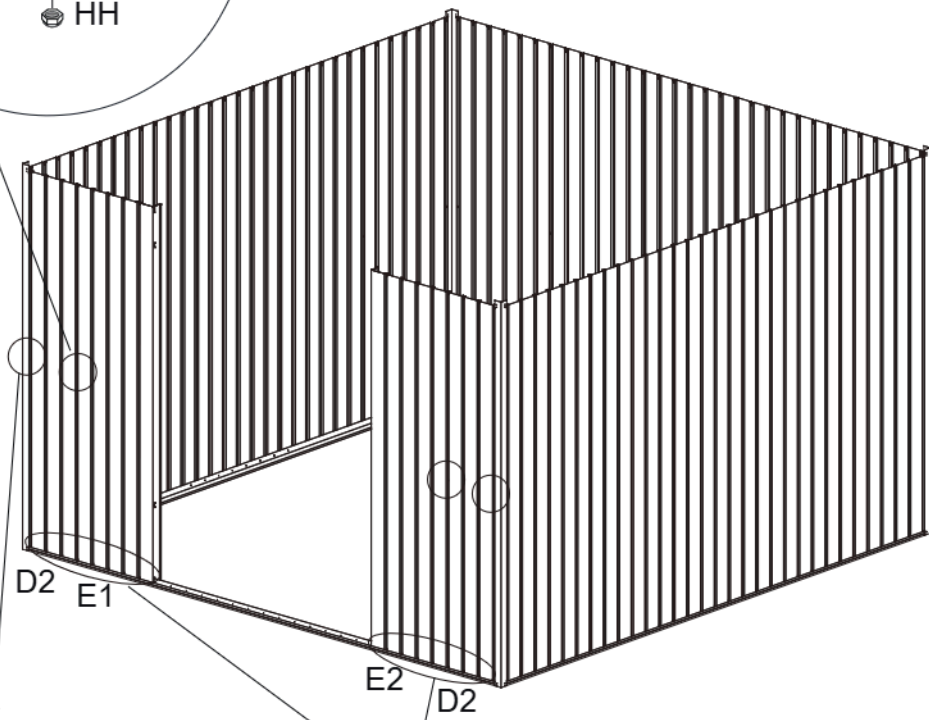
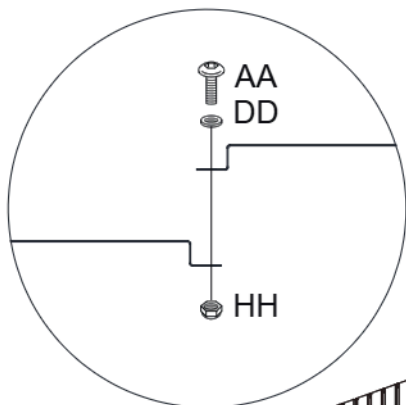
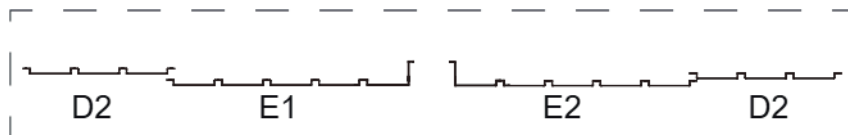



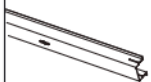

Q

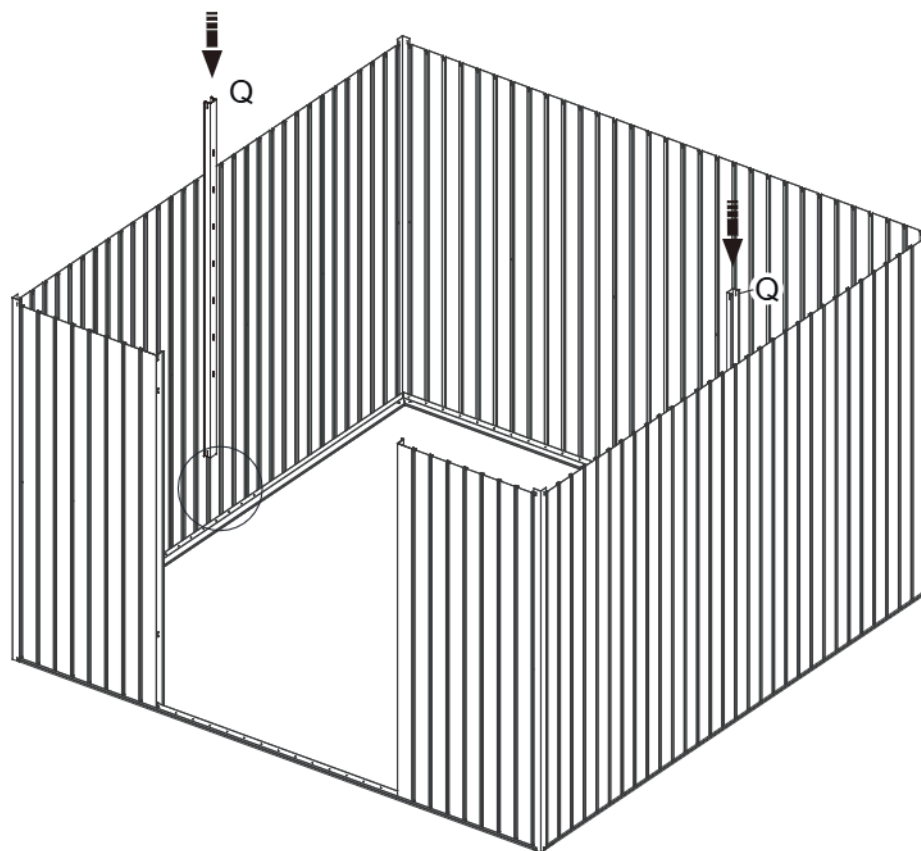
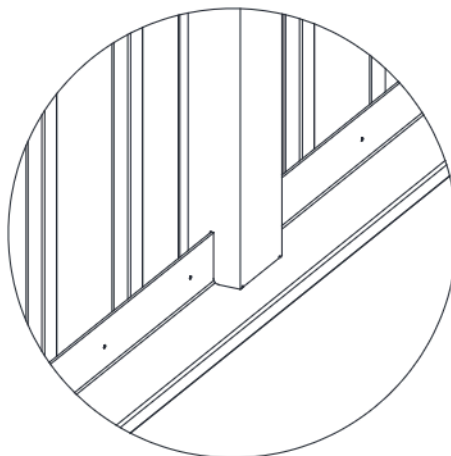
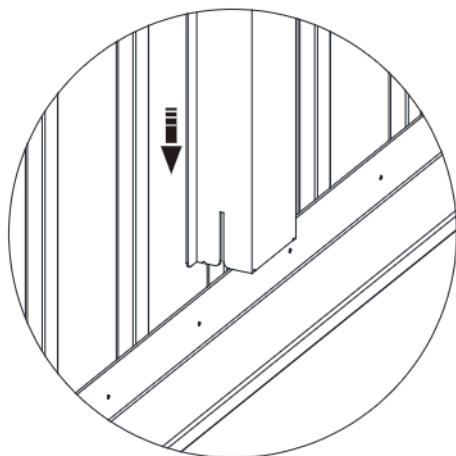

7. Assembler le poteau de renfort.

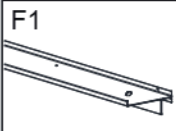
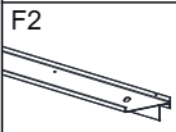
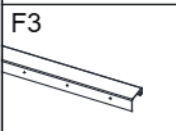

8. Assembler les poutres supérieures.



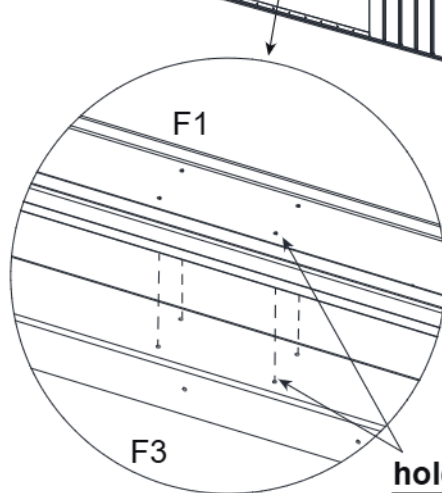
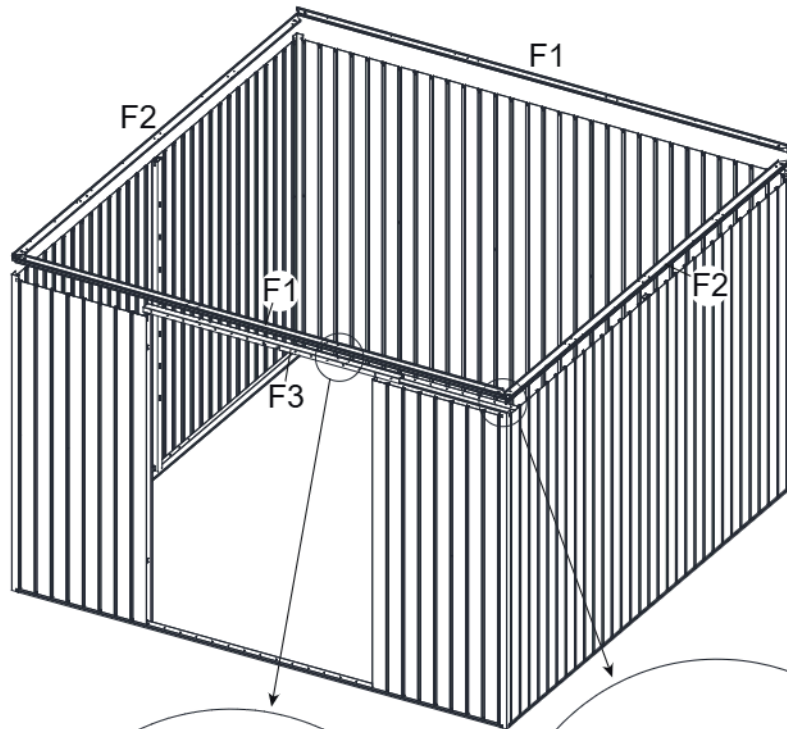
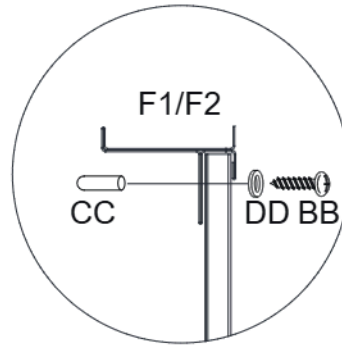

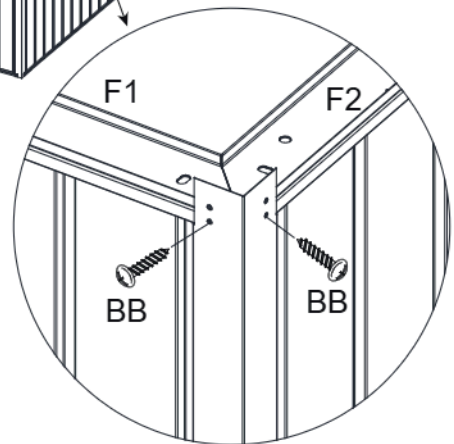

F1		2X
F2		2X
F3		1X
BB M4*12		117X
CC		109X
DD M5		109X





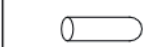

hole alignment

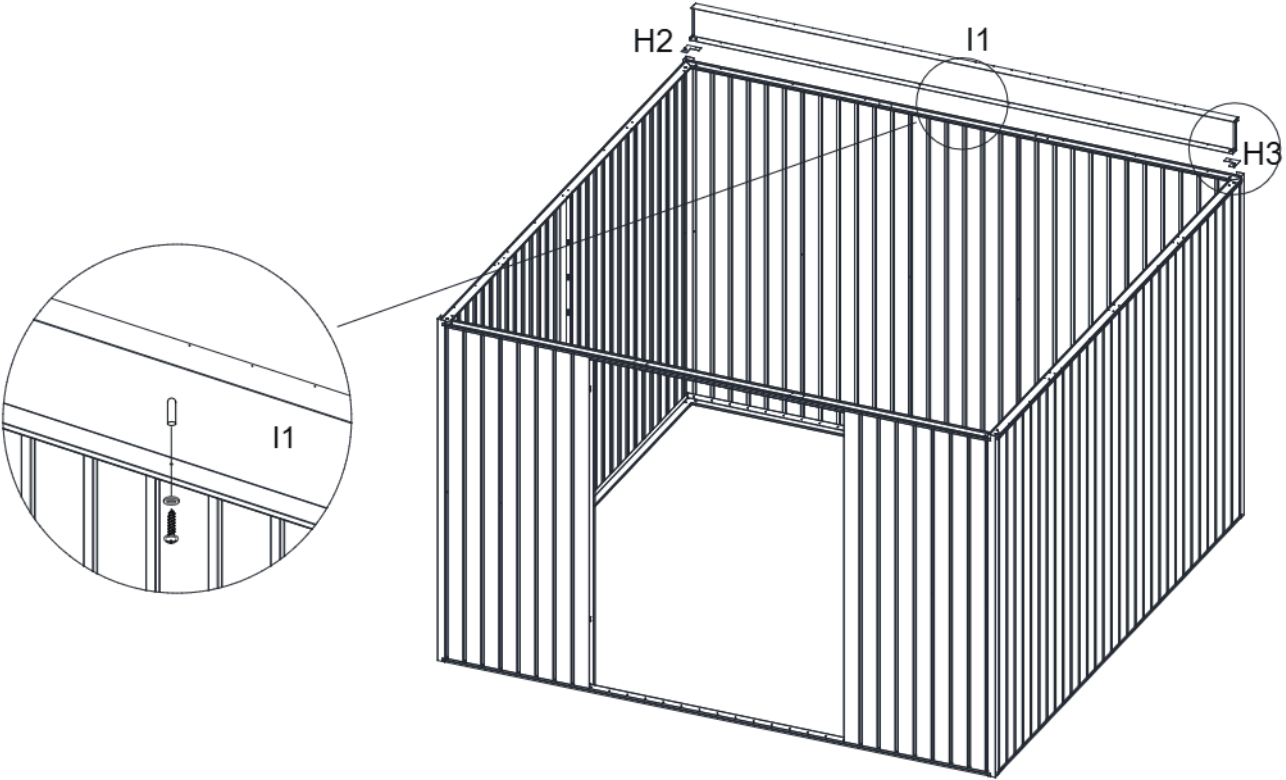
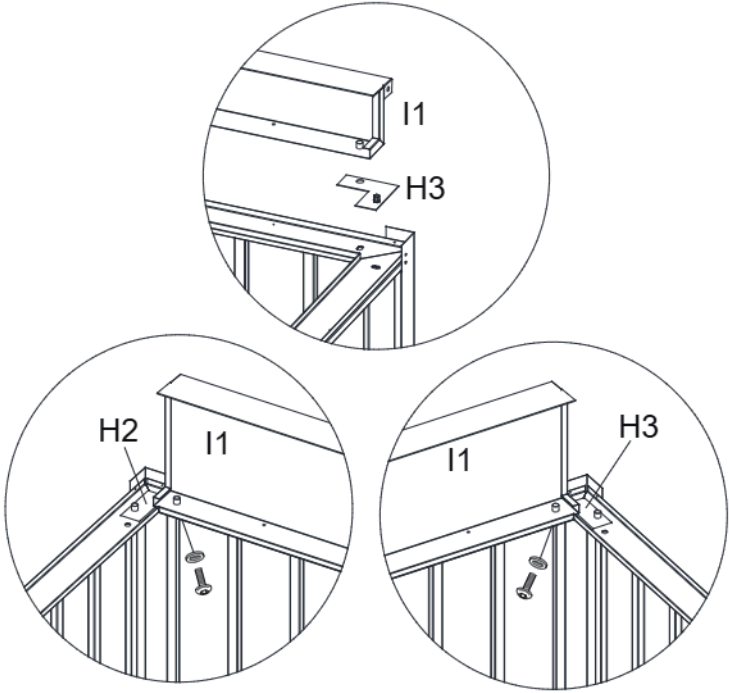

9. Assembler le support de fenêtre.







I1		1X
H2		1X
H3		1X
AA M5*10		2X
BB M4*12		8X
CC		8X
DD M5		10X

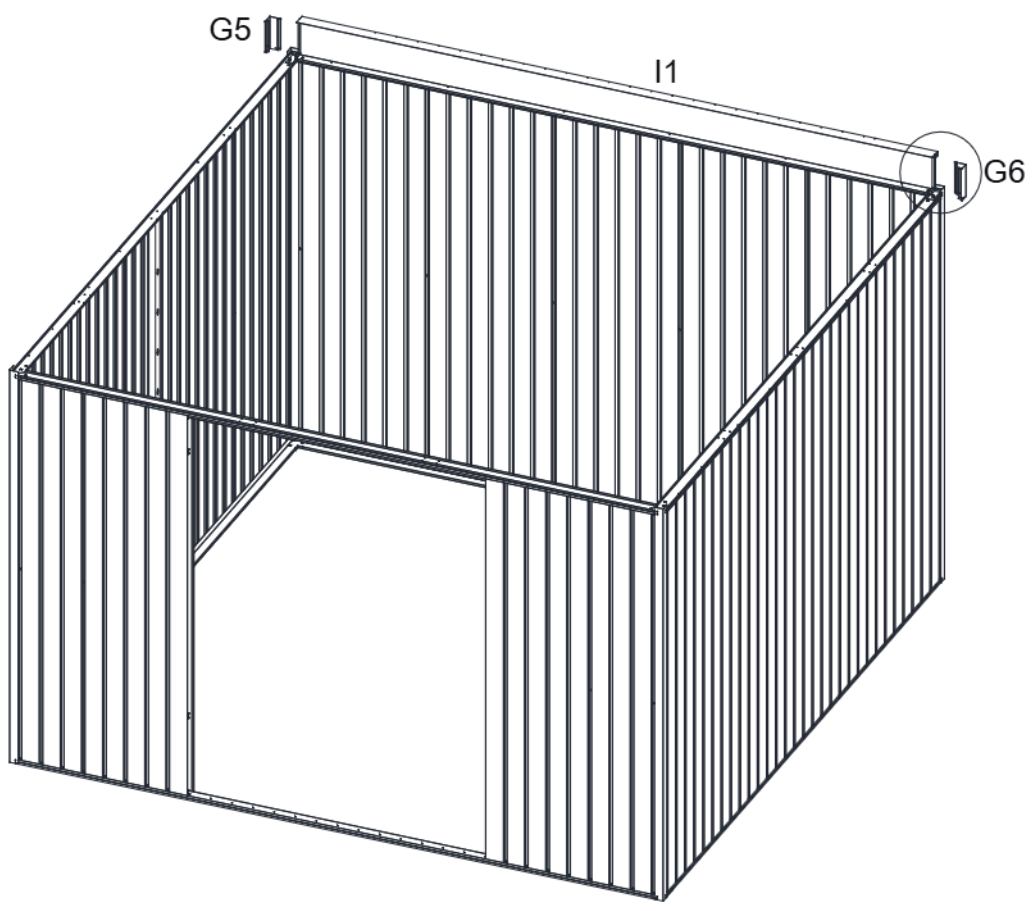
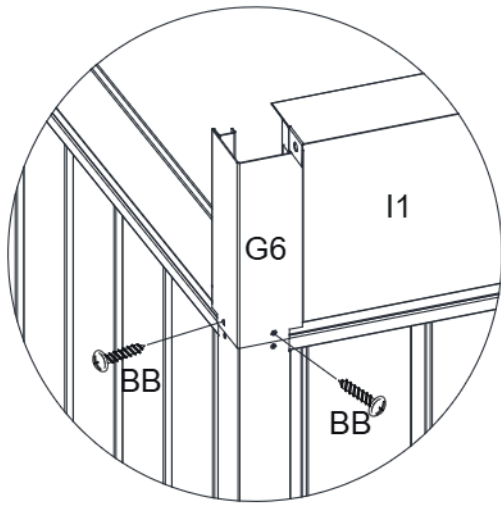

- G5  1X
- G6  1X
- BB M4*12  4X

10. Assembler le reste des poutres.







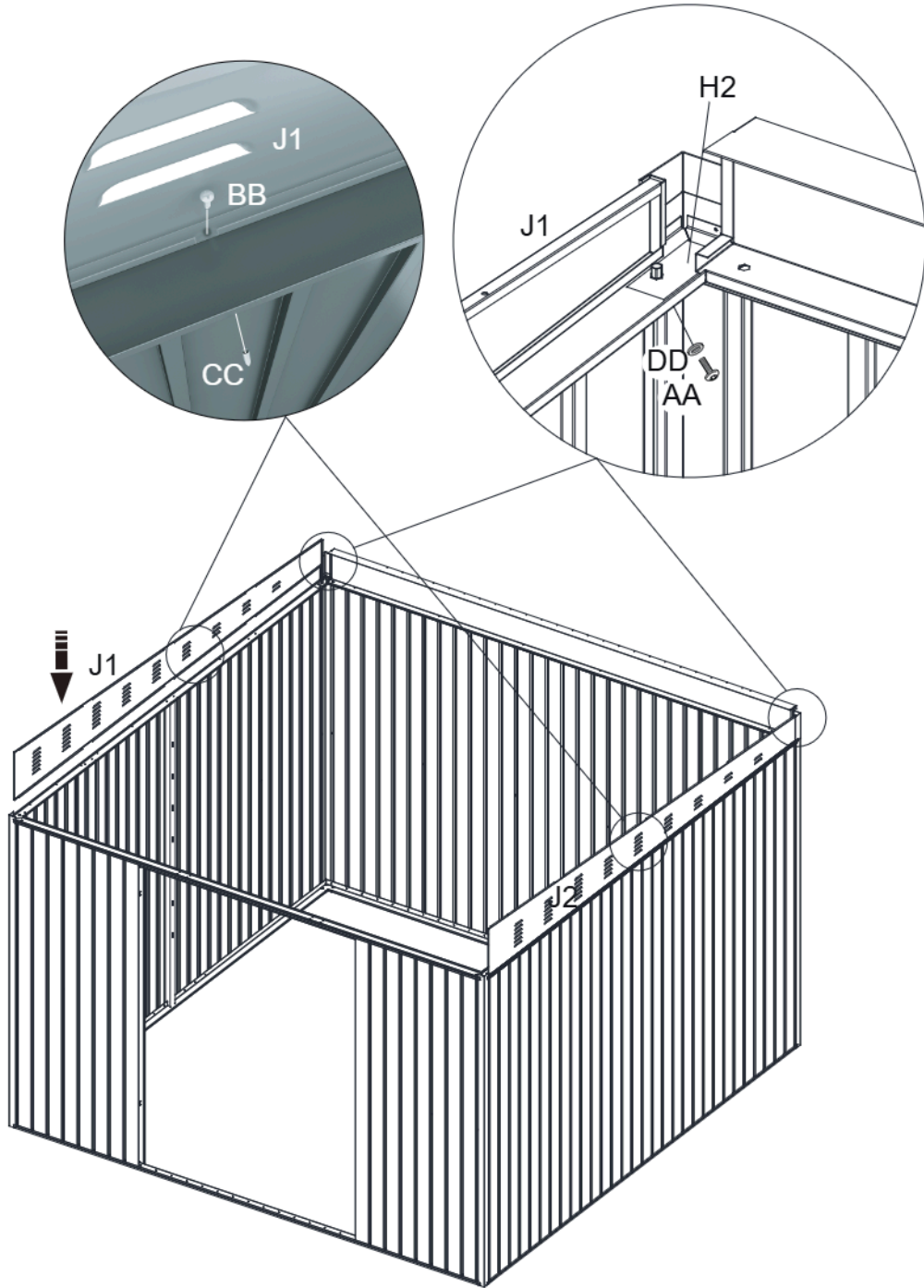



J1		1X
J2		1X
AA M5*10		2X
BB M4*12		12X
CC		12X
DD M5		2X



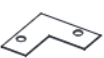

11. Verrouiller les panneaux supérieurs

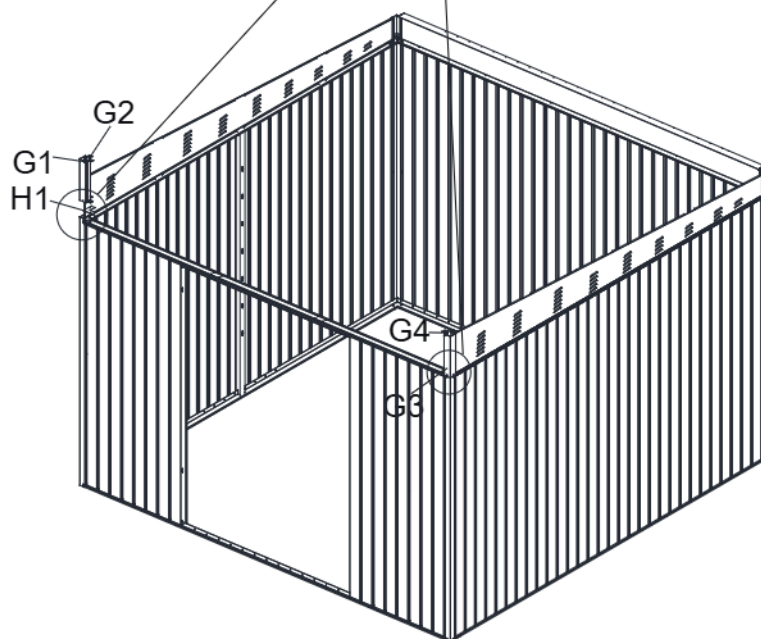
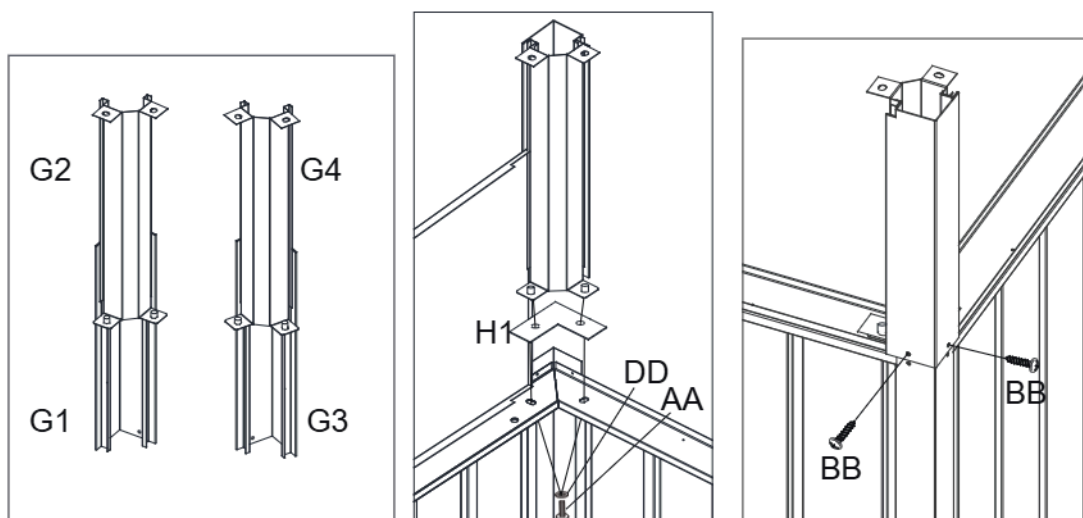

12. Assemblage des 2 panneaux avant.

G1		1X
G2		1X
G3		1X
G4		1X
H1		2X
AA M5*10		4X
BB M4*12		4X
DD M5		4X







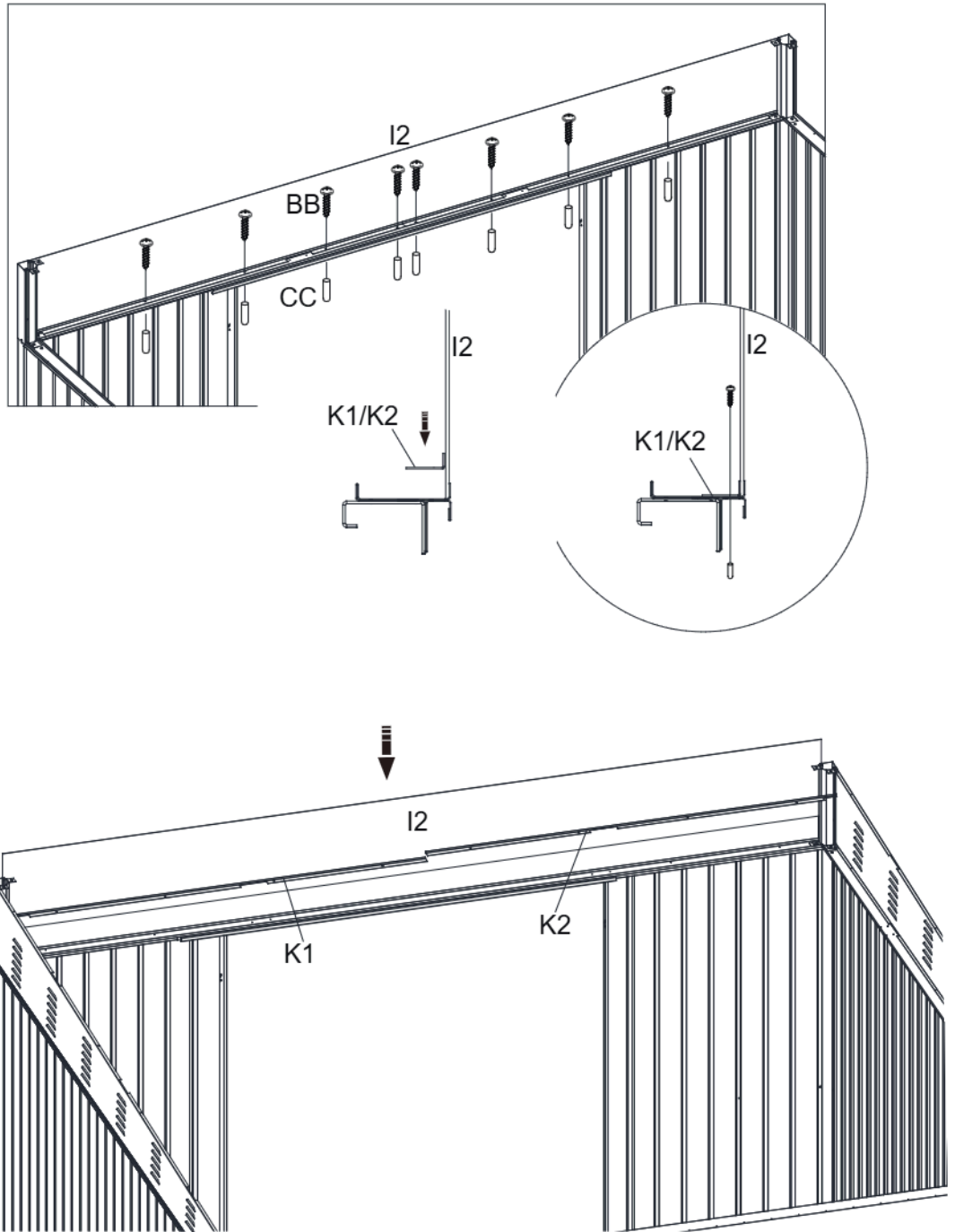

I2		1X
K1		1X
K2		1X
BB		8X
CC		8X







13. Assembler le support de fenêtre avant.

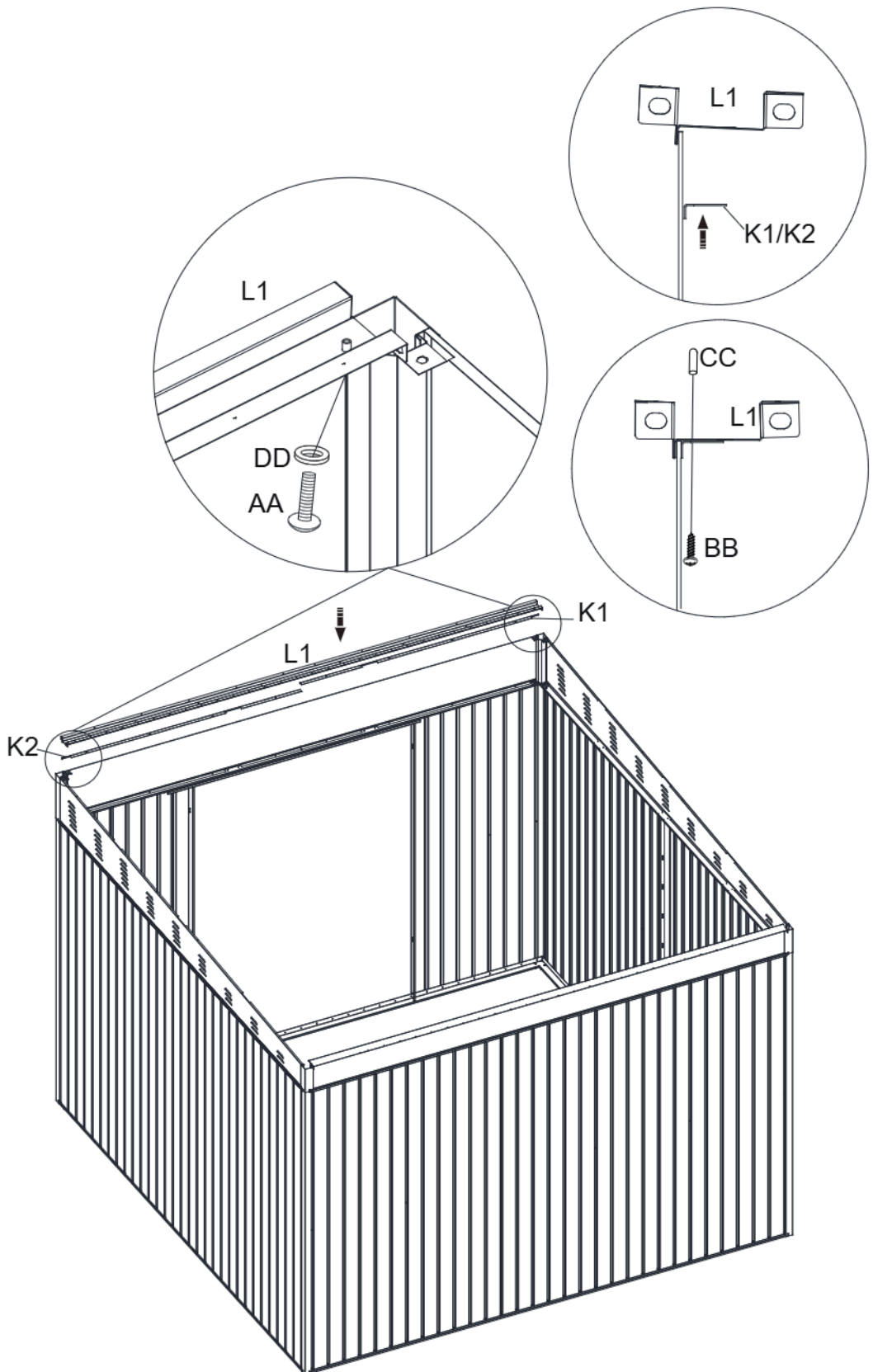

14. Assembler l'avant-toit et la plaque de maintien.

L1		1X
K1		1X
K2		1X
AA M5*10		2X
BB M4*12		8X
CC		8X
DD M5		2X







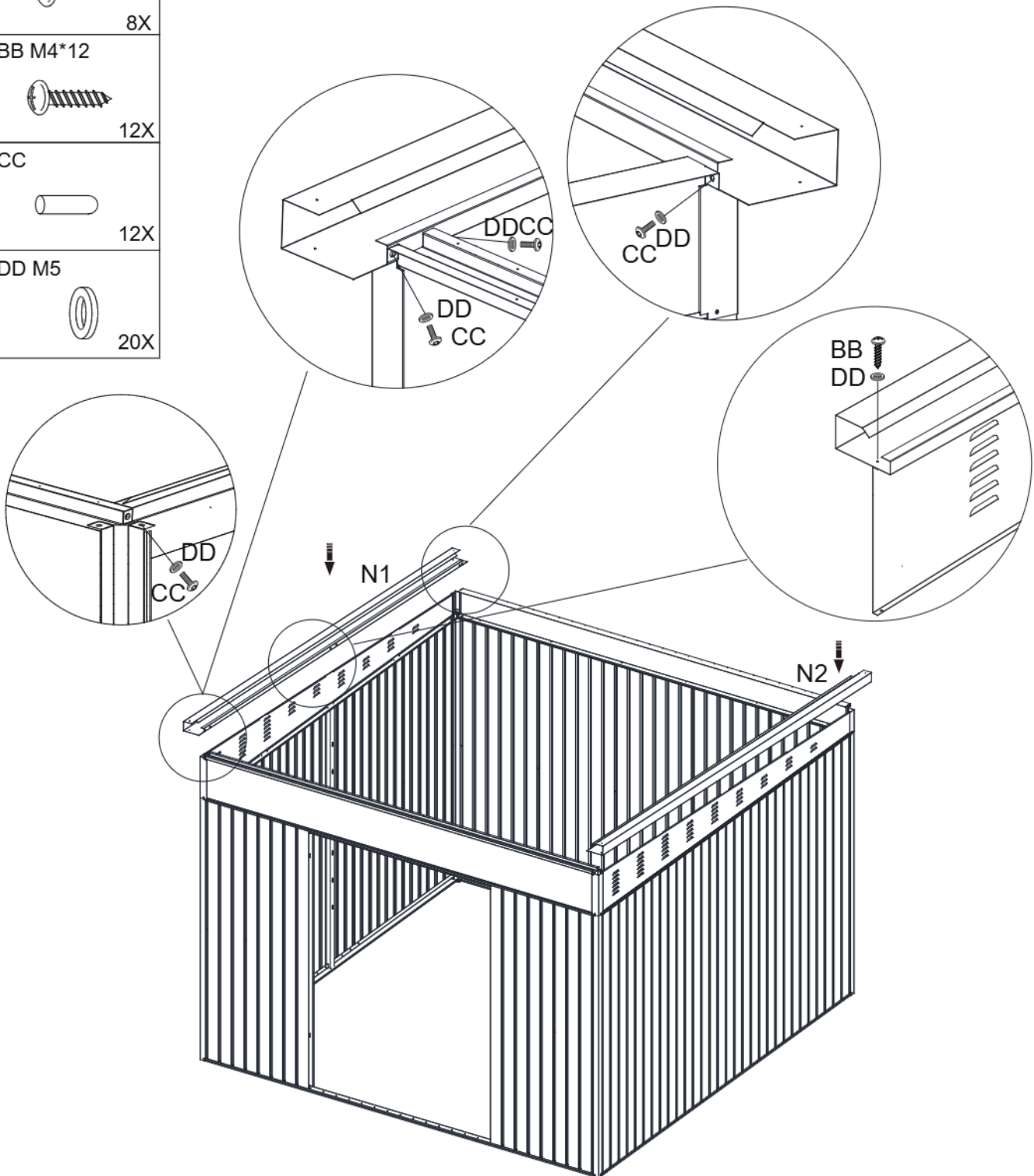



N1		1X
N2		1X
AA M5*10		8X
BB M4*12		12X
CC		12X
DD M5		20X



15. Assemblez les avant-toits gauche et droit



16. Assembler la jambe de support.

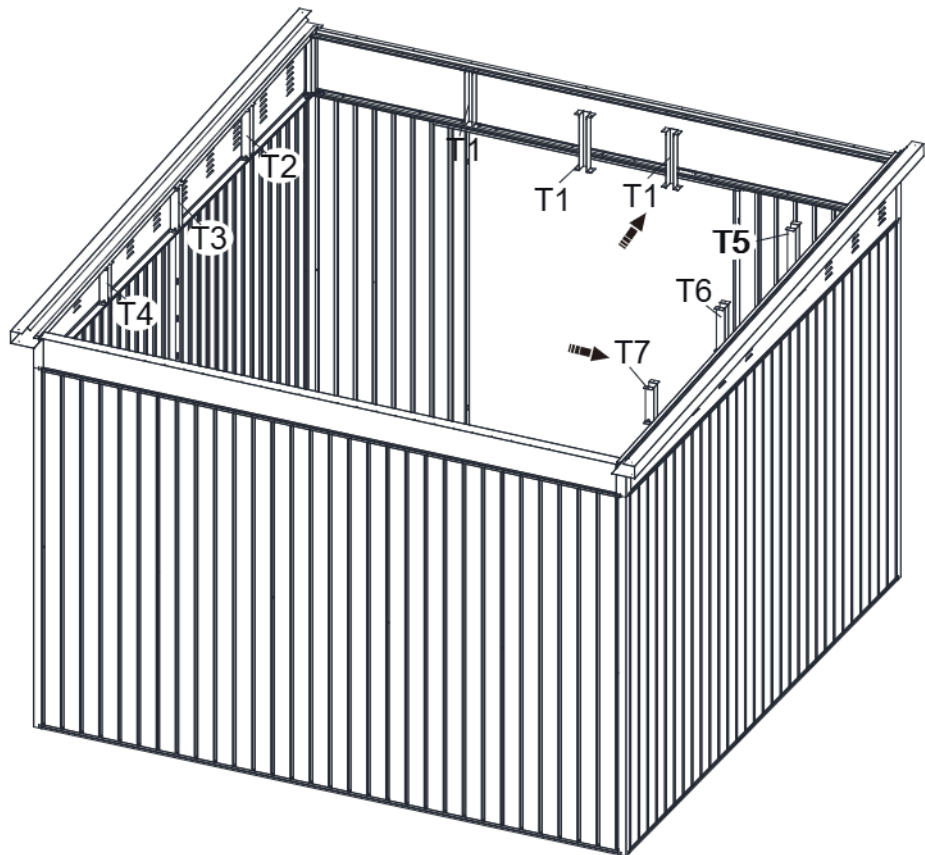
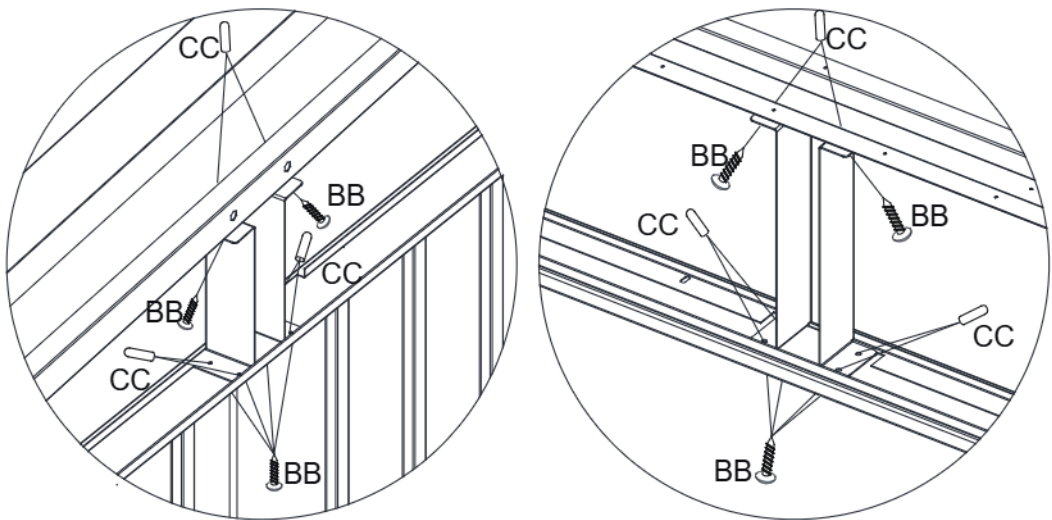





T1		3X
T2		1X
T3		1X
T4		1X
T5		1X
T6		1X
T7		1X
BB M4*12		54X
CC		54X

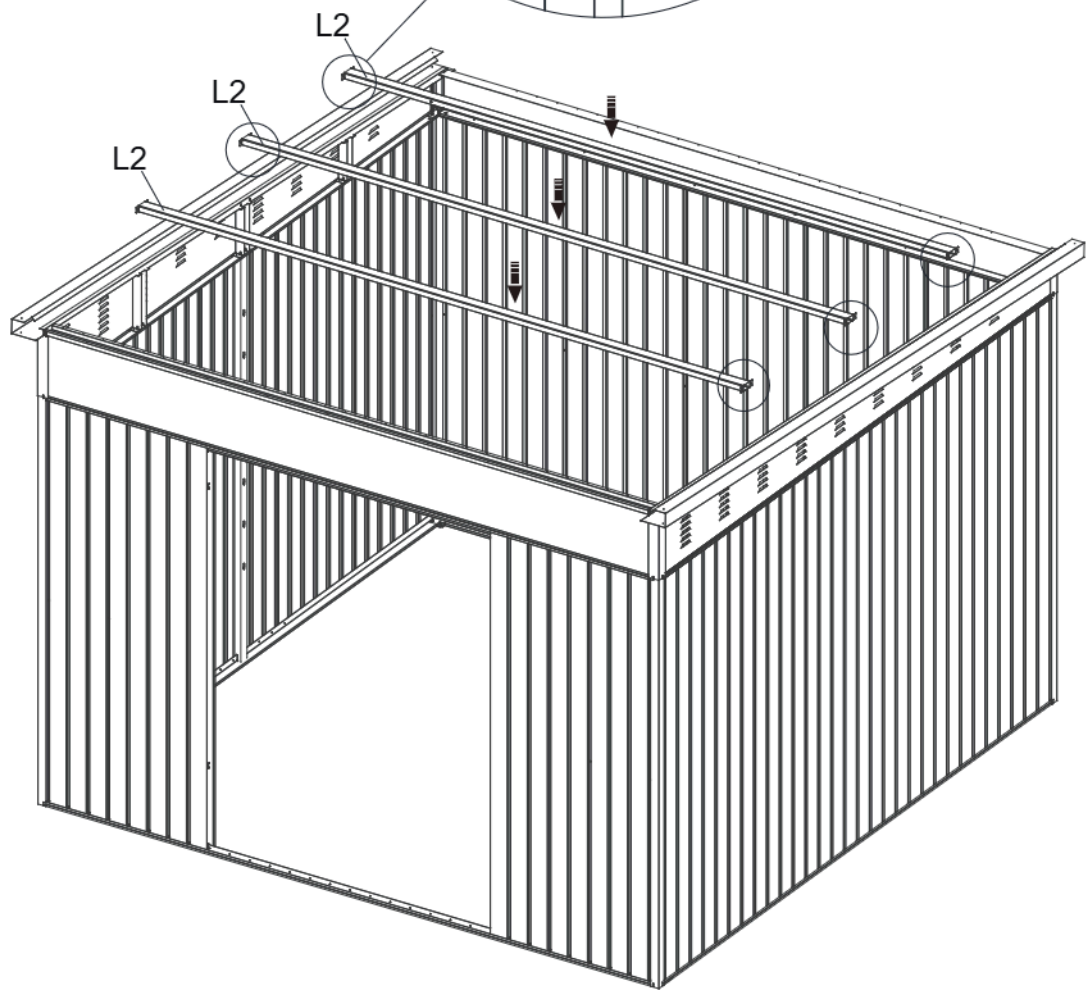
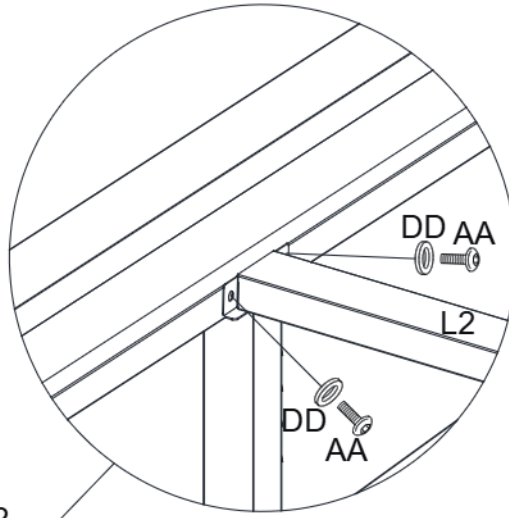

- L2  3X
- AA M5*10  12X
- DD M5  12X

17. Assemblez le support central.







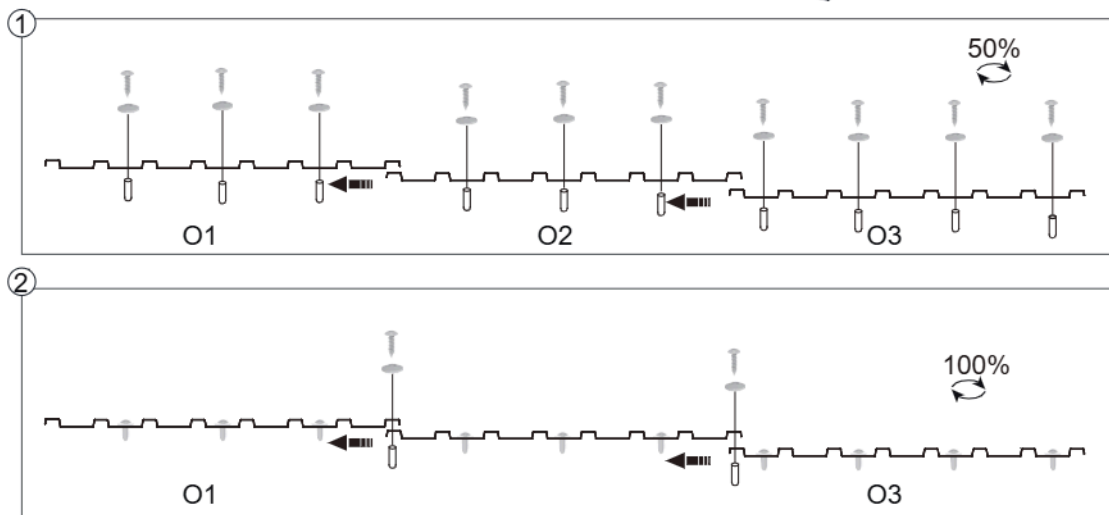
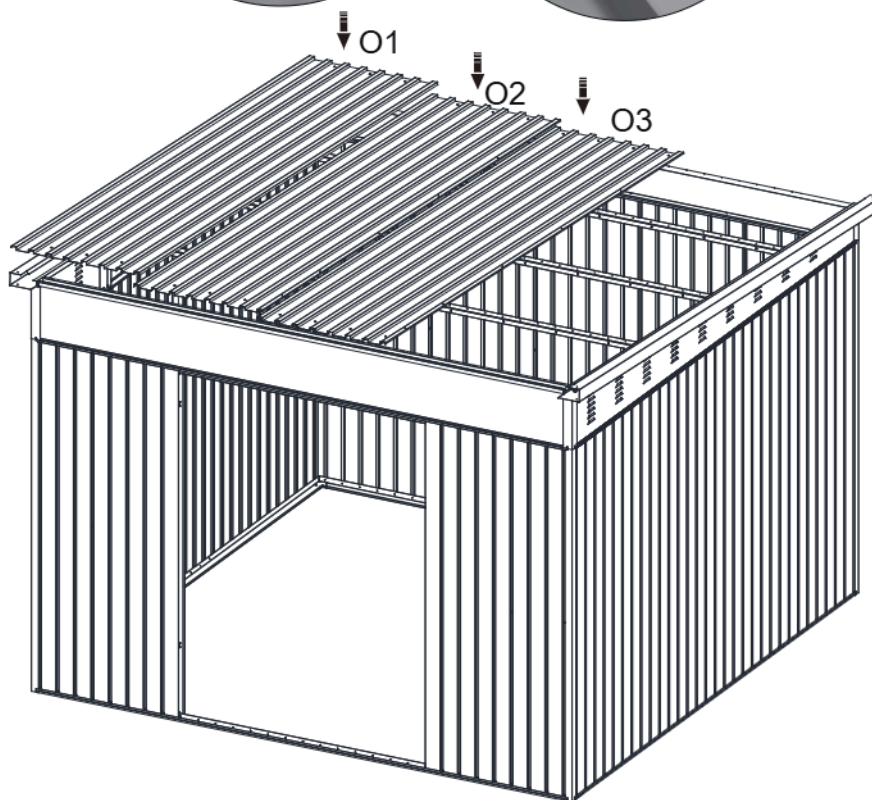
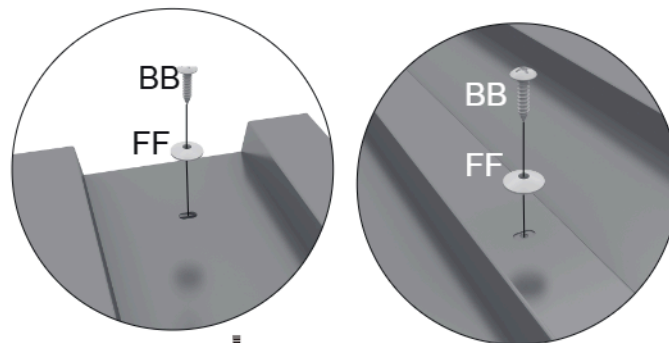

O1		1X
O2		1X
O3		1X
BB M4*12		34X
CC		34X
FF M5		34X

18. Assembler les panneaux de toit.

Notez que lors de l'assemblage, fixez d'abord le O3, puis fixez le O2 et le O1 dessus



Ne serrez pas les vis auto taraudeuses maintenant, de sorte qu'il y aura un espace permettant les mouvements des panneaux de toit entre la gauche et la droite.

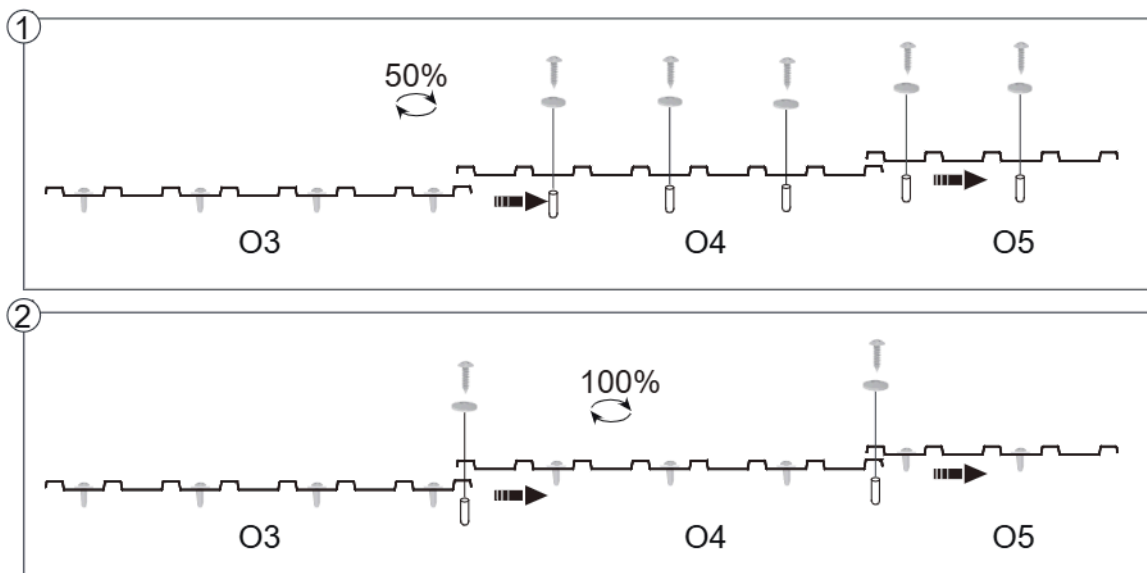
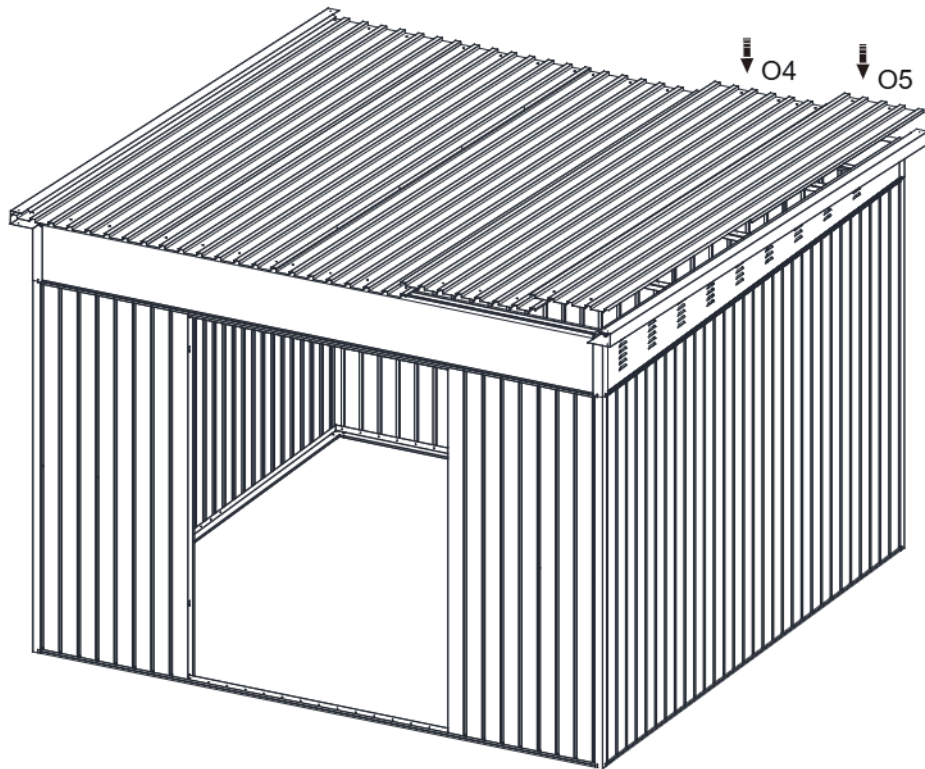
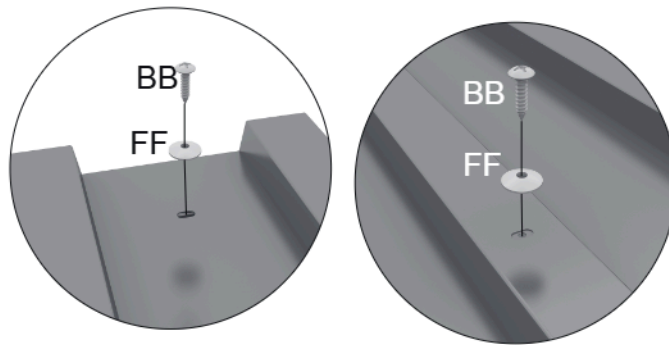

O4		1X
O5		1X
BB M4*12		24X
CC		24X
FF M5		24X

19. Assembler les panneaux de toit.

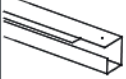

M1		1X
BB M4*12		10X
DD M5		10X

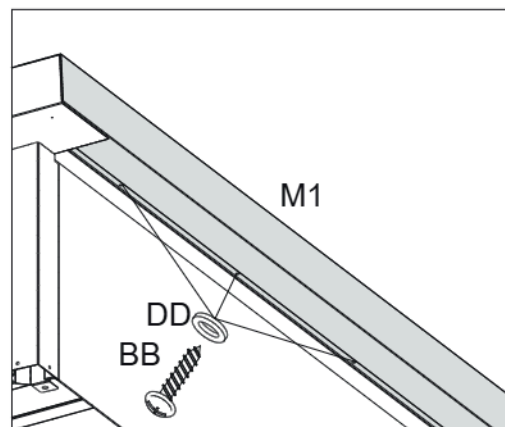
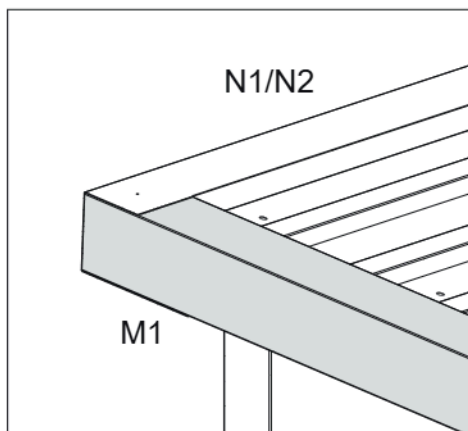
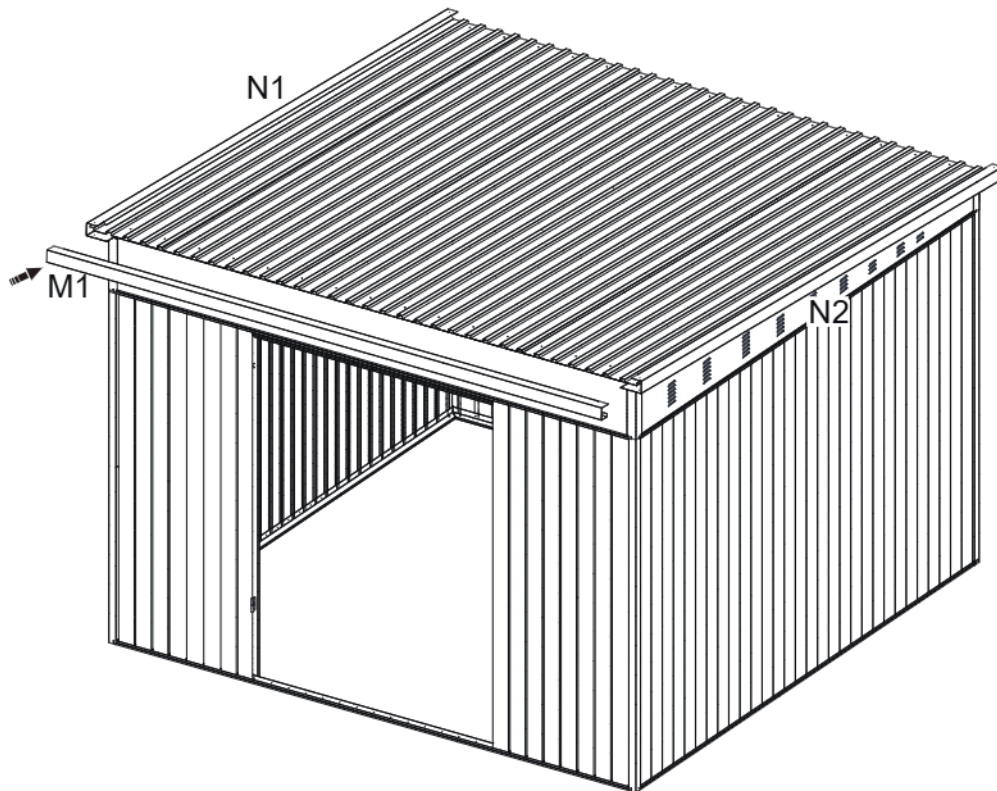

20. Assembler la bande de chant avant M1.

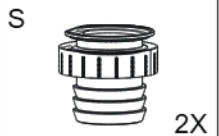

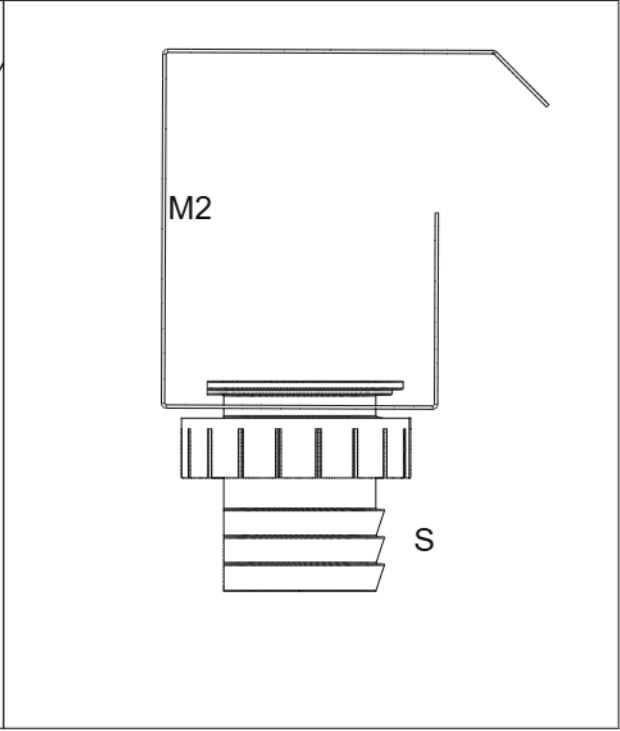
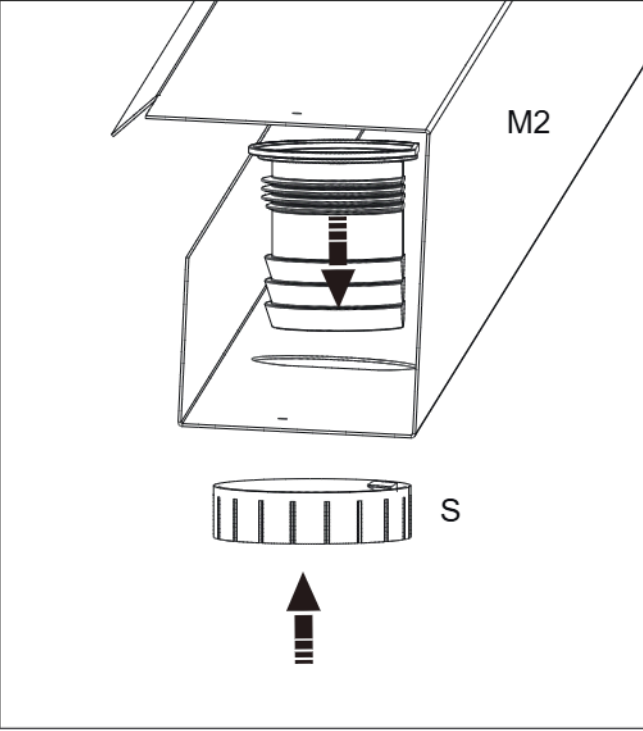
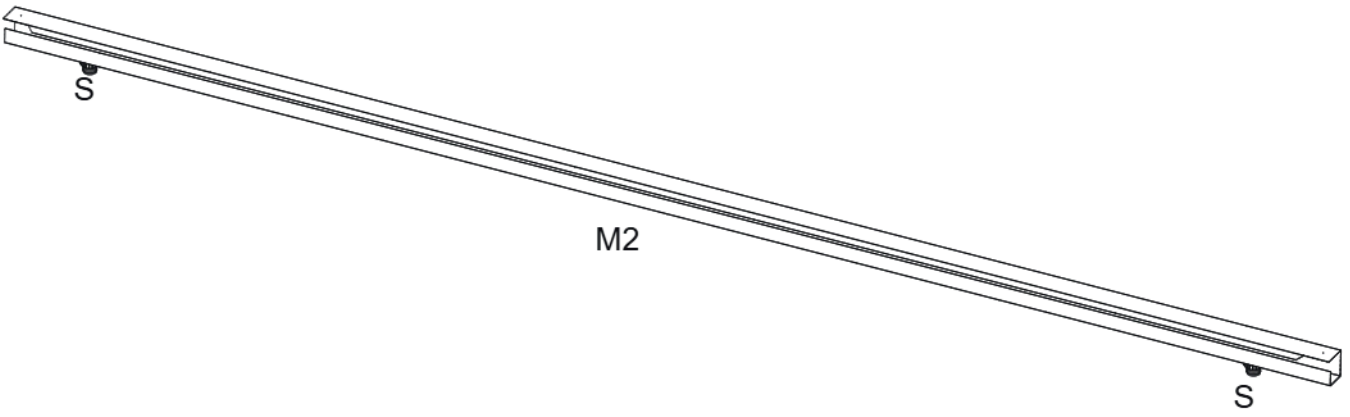
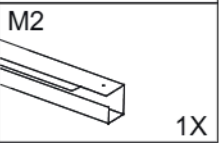

21. Assembler les éléments de drainage sur la bande de chant arrière



P		4X
BB M4*12		8X
FF		8X

22. Assemblez l'avant-toit arrière et les quatre protections d'angle.

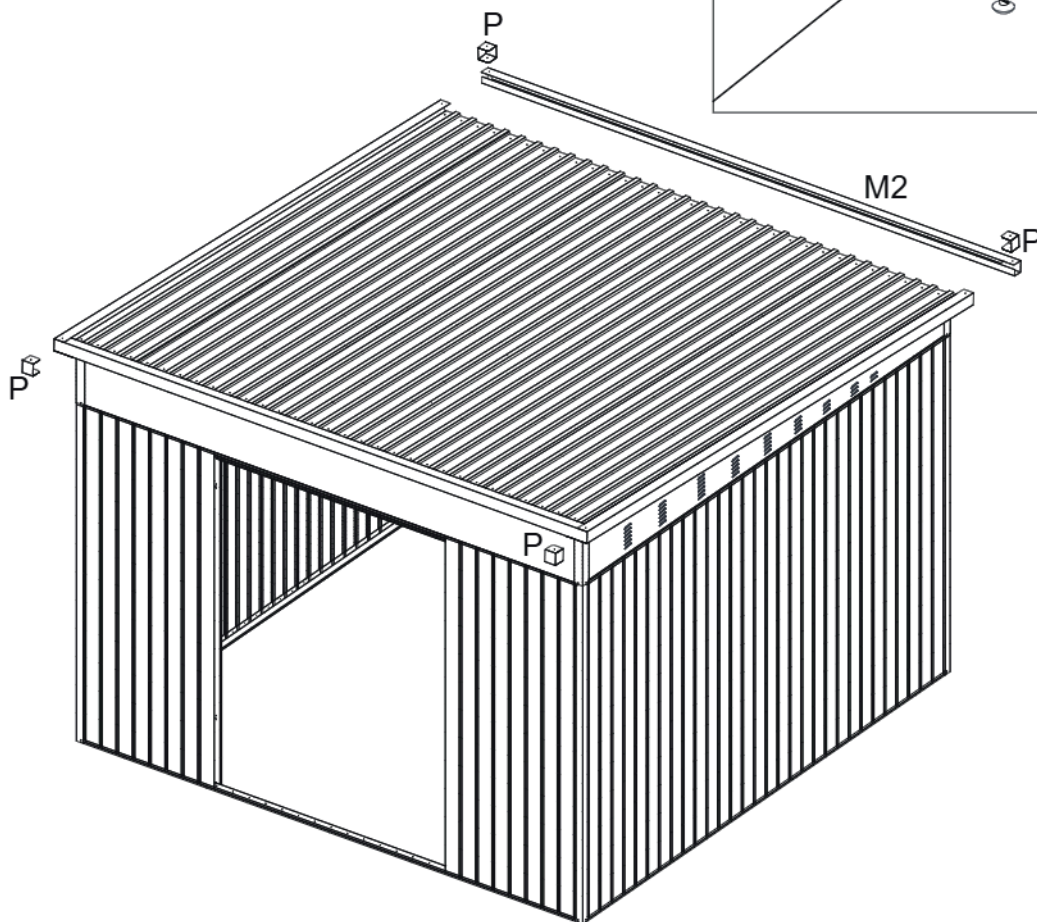
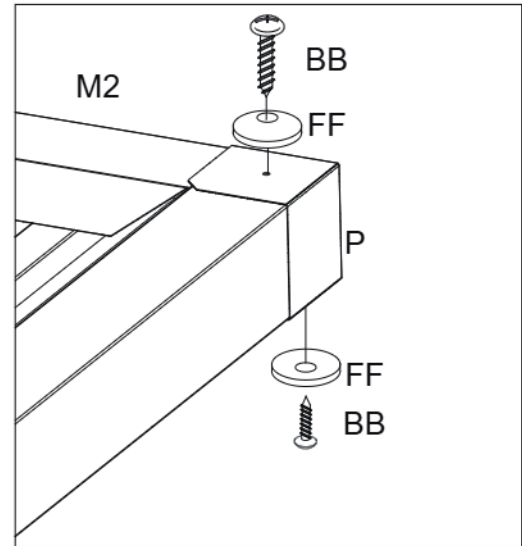
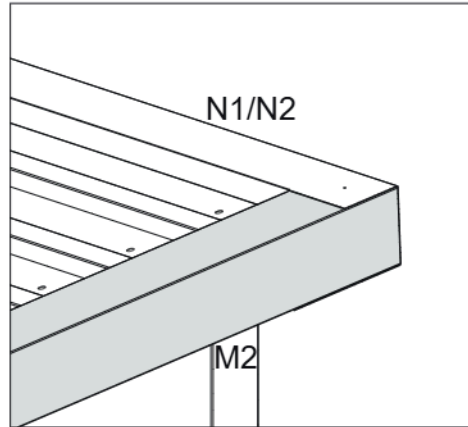

R1







28X

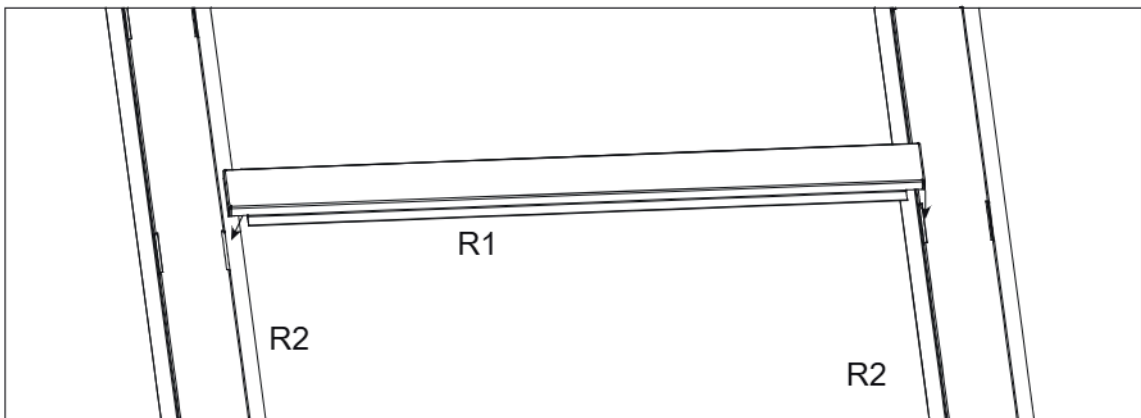
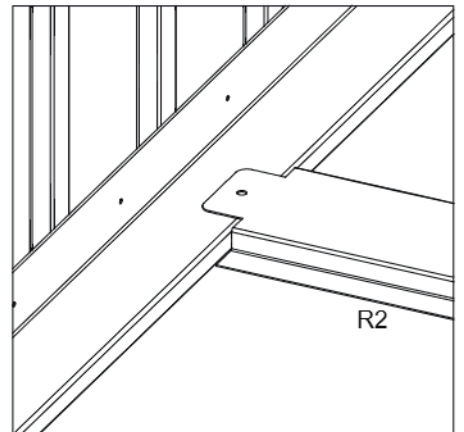
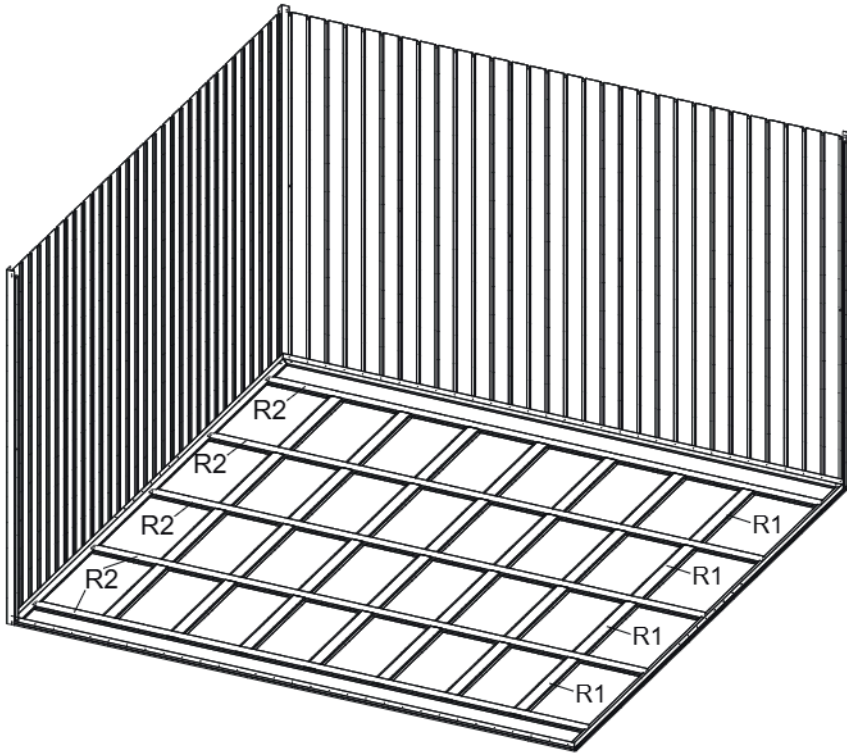

5X







23. Assembler le chassis du sol.

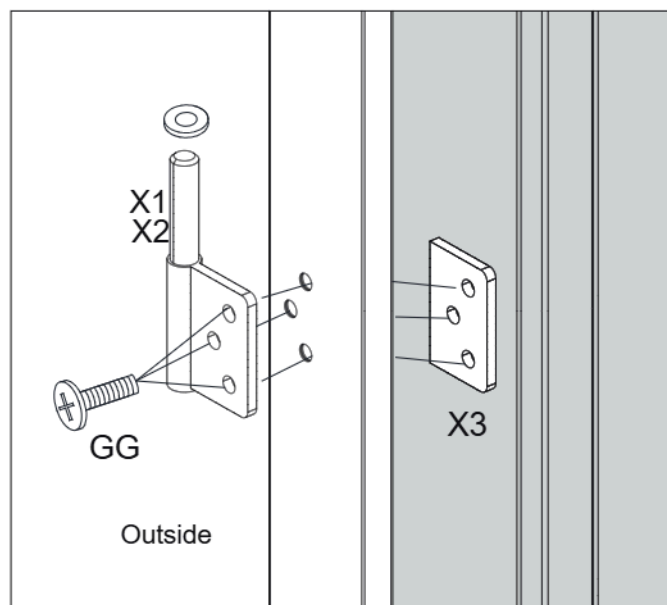
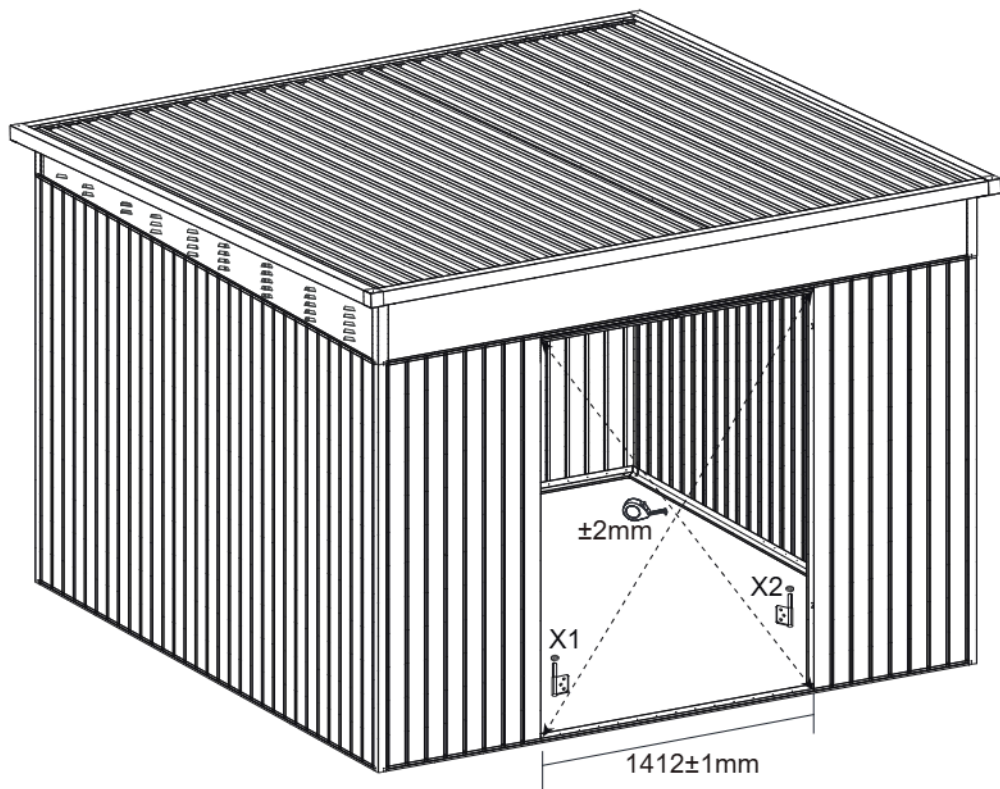

X1		1X
X2		1X
X3		2X
GG M4*10		6X





24. Assemblez le jeu de charnières et les languettes de renfort au bas du cadre de porte des deux côtés.
 Notez l'orientation des charnières.

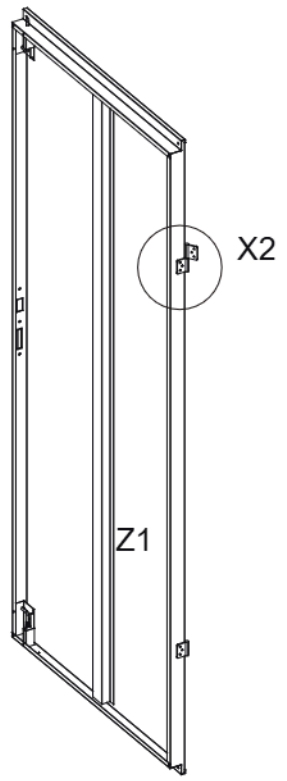
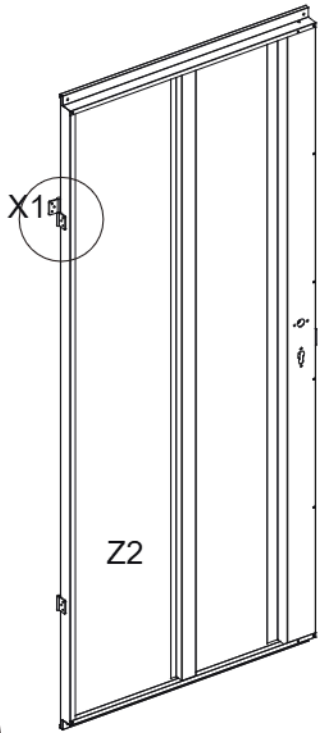
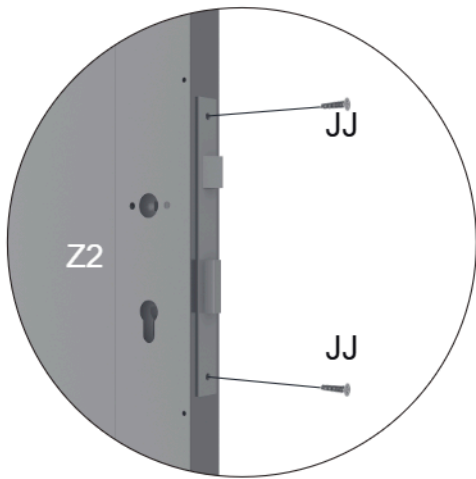
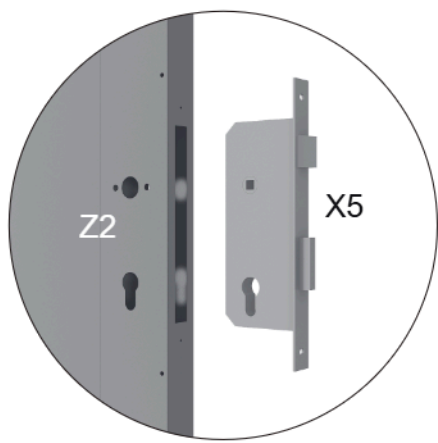
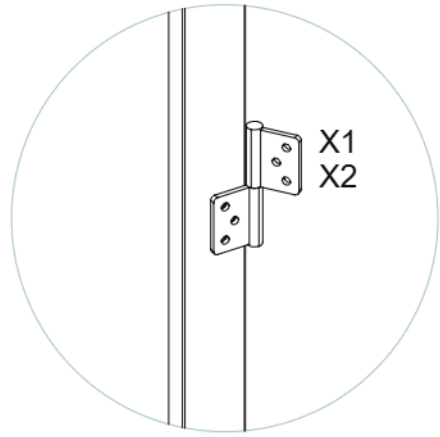
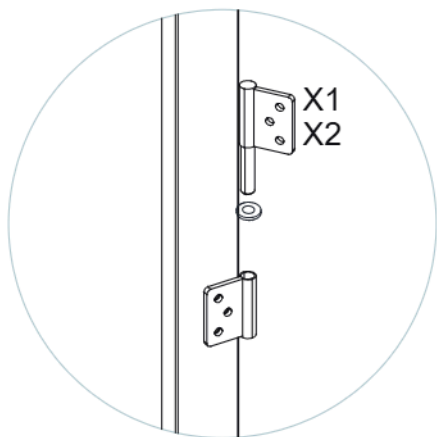

X1		1X
X2		1X
X5		1X
JJ M4*20		2X
Z1		1X
Z2		1X



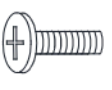



25. Insérez la charnière dans la charnière sur le côté supérieur de la porte, puis assemblez le cylindre de serrure.

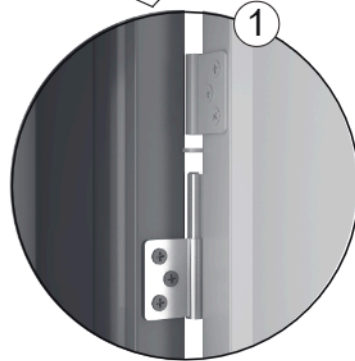
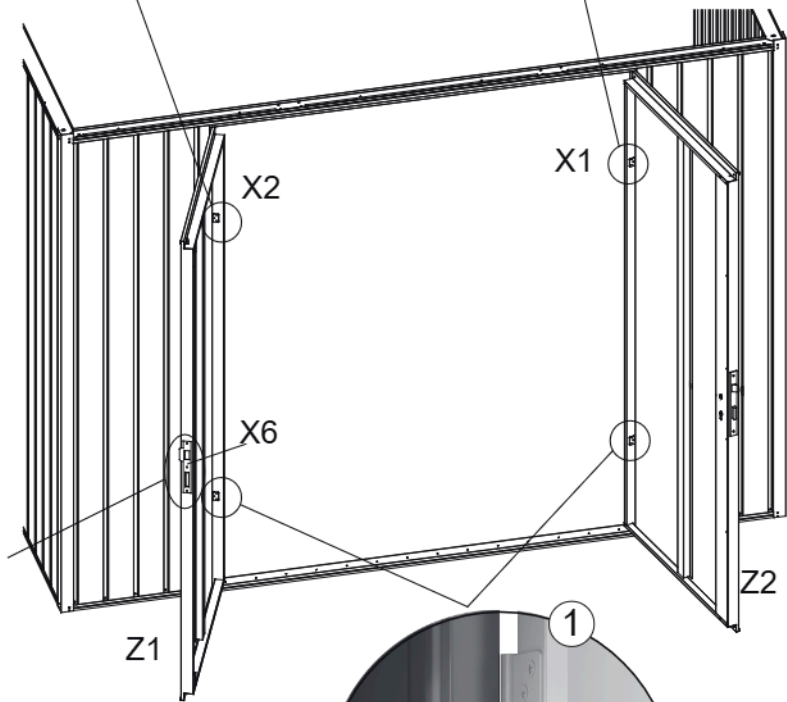
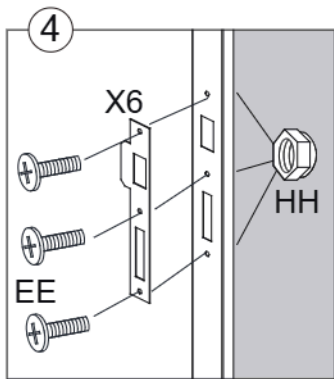
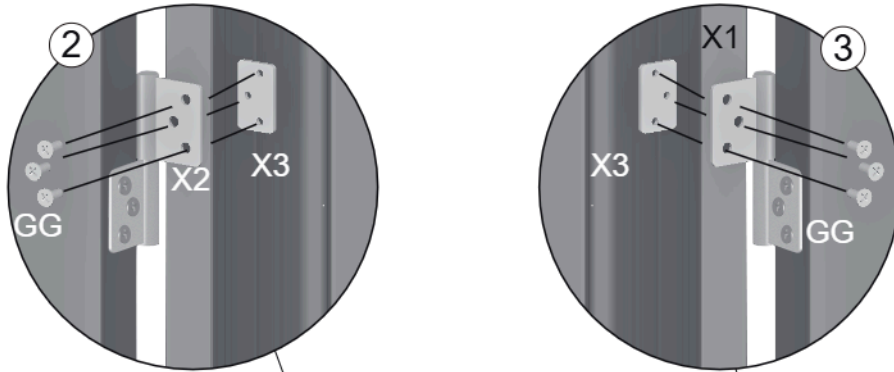

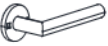
X3		2X
X6		1X
EE M5*10		3X
GG M4*10		6X
HH M5		3X





26. Fixez la porte aux cadres des deux côtés de l'abris.

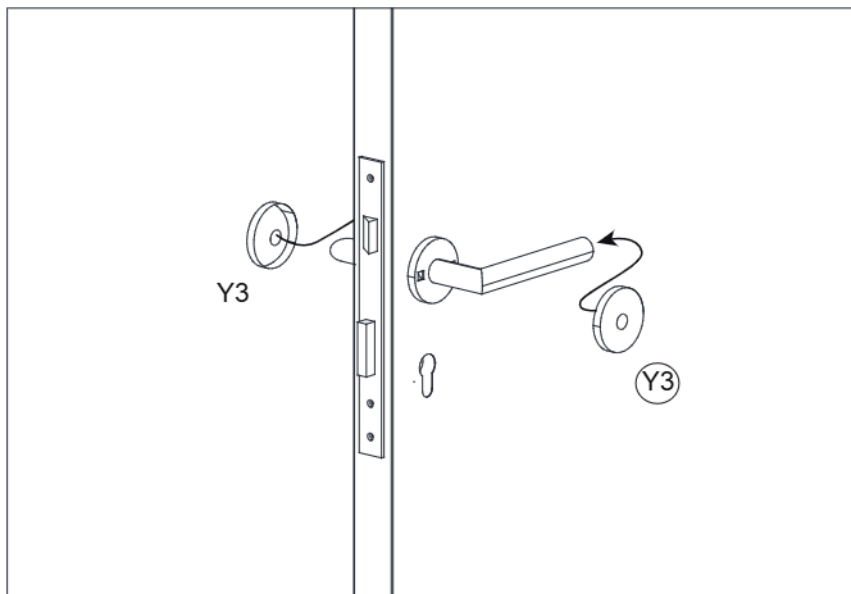
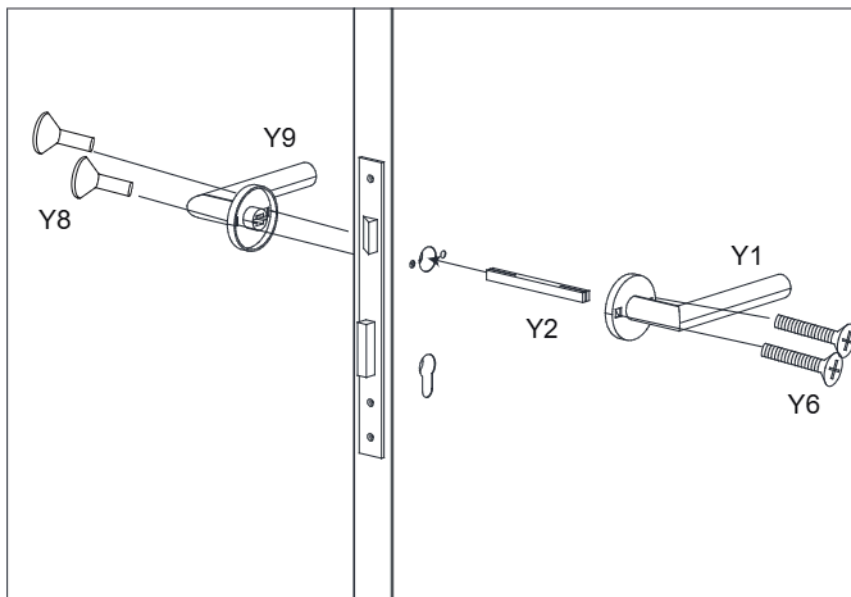

Y1		1X
Y2		1X
Y3		2 X
Y6 M5*35		2X
Y8		2X
Y9		1X

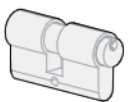

27. Assemblez la poignée de porte.

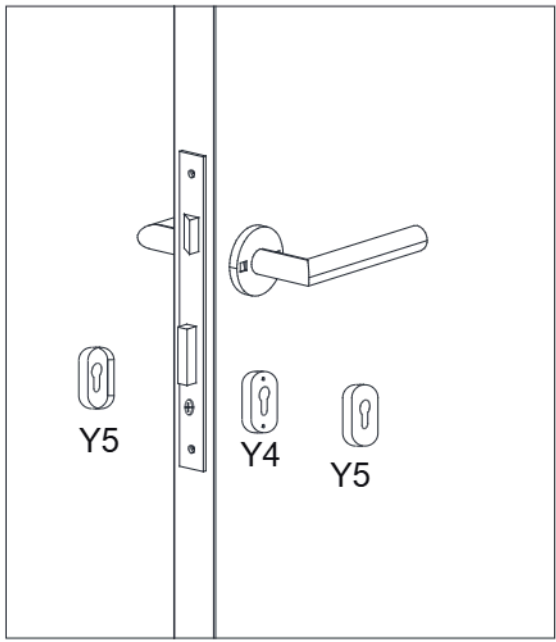
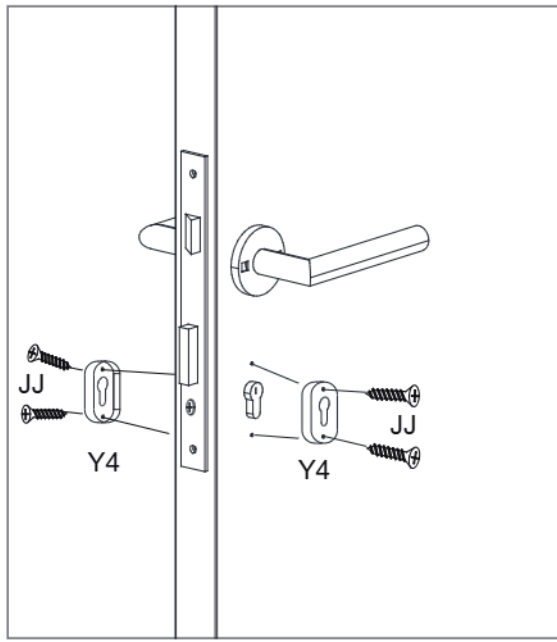
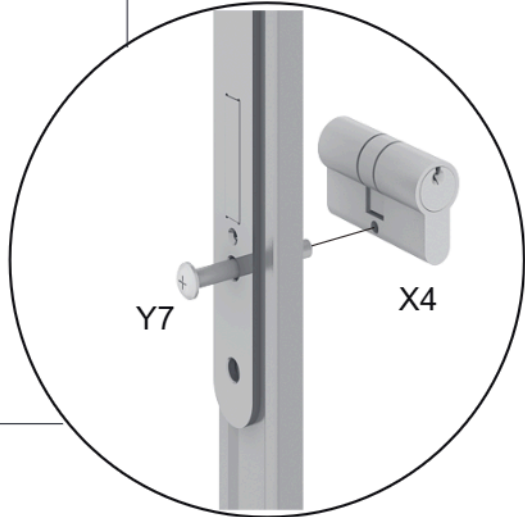
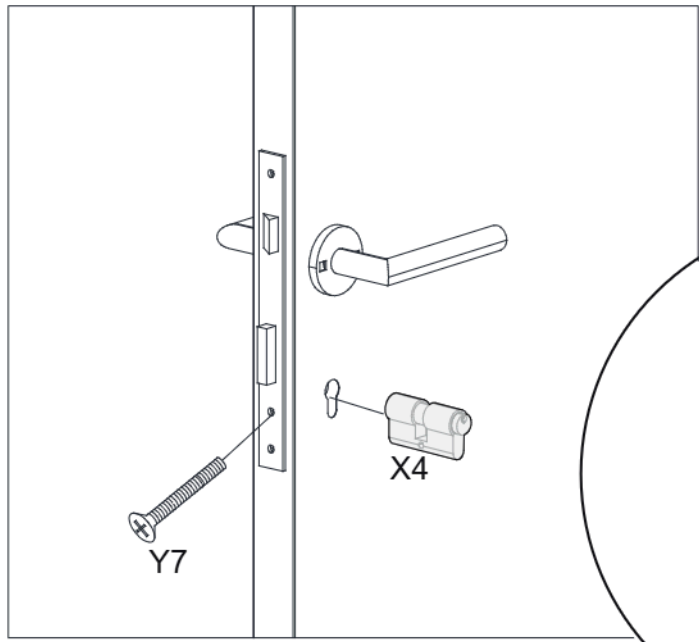

- X4  1X
- Y4  2X
- Y5  2X
- Y7 M5*50  1X
- JJ M4*20  4X

28. Installez le cylindre de serrure et le petit carénage.



U		4X
V		2X
W		4X

29. Assembler les dispositifs anti-tempête.

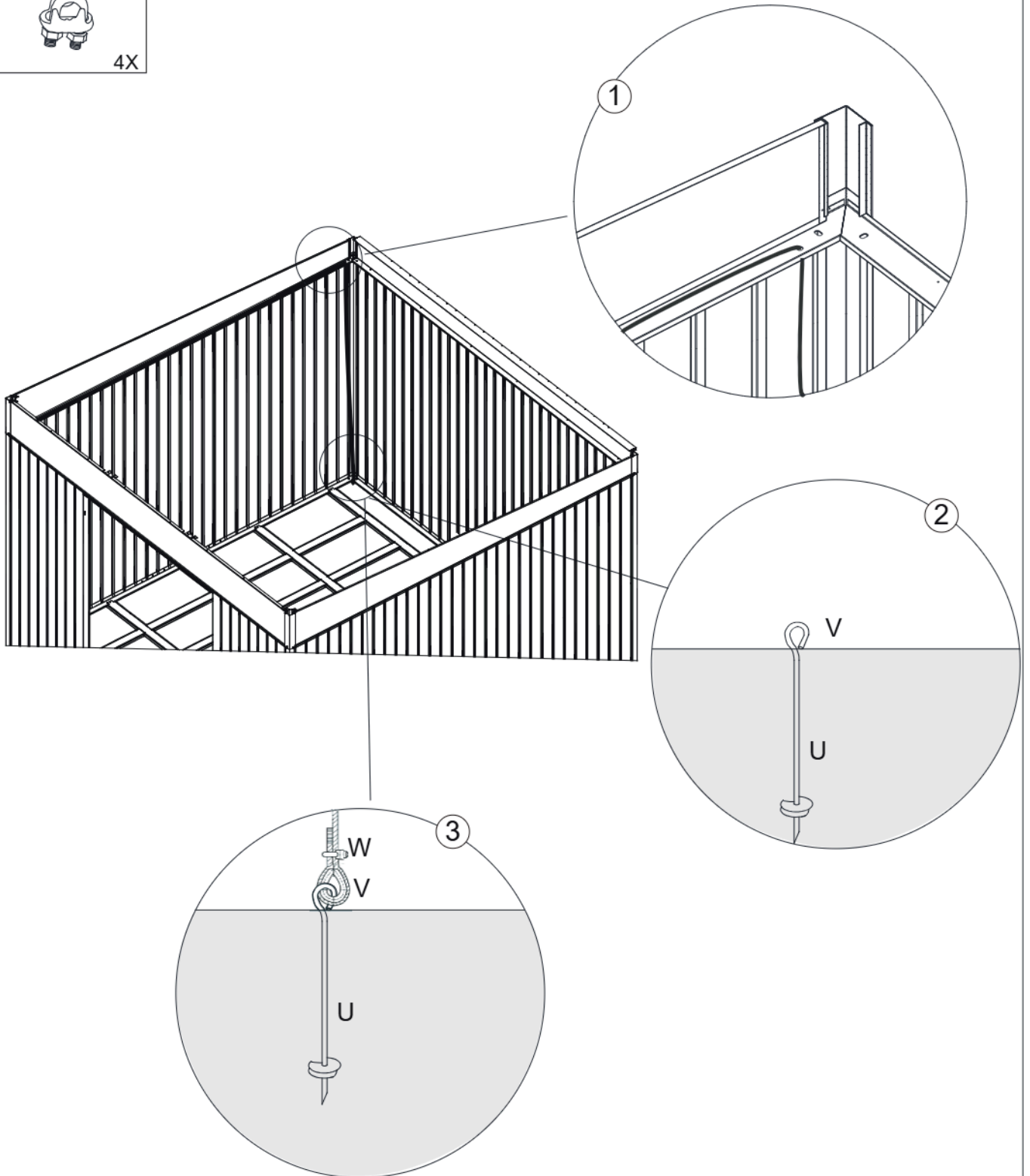



Conditions d'application:

Une information doit nous parvenir à l'adresse mail sav@green-outside.com, ou par courrier à Green Outside, 21 route d'Alex, 01100 Bellignat avec les éléments suivant :

- Facture d'achat acquittée précisant le lieu, la date et la référence produit
- Le descriptif précis du problème rencontré, ainsi que toute précision utile liée notamment à la pose
- Des photos sous différents angles, de qualité suffisante pour faciliter la compréhension du défaut rencontré, et permettre d'apporter une réponse adaptée.

Dans le cadre de sa politique d'amélioration continue, Green Outside se réserve le droit de modifier ses produits sans préavis.

Pour plus d'information sur les produits **Green Outside**:

info@green-outside.com et www.green-outside.com

